



Part 9 (91, 94)  
INSTRUMENTS  
HEATER SYSTEM  
P 120

**CARS**

# **SERVICE MANUAL**

## CONTENTS

### Group 91, Instruments

Description .....	1
Combined instrument .....	1
Fuel gauge including tank fitting .....	2
Speedometer .....	2
Temperature gauge .....	3
Oil pressure contact .....	3
Windscreen wiper .....	4
Repair instructions	
Replacing the combined instrument .....	4
Checking the fuel gauge .....	4
Replacing the fuel gauge dial .....	5
Replacing the tank fitting .....	5
Adjusting the speedometer .....	5
Checking the speedometer cable .....	5
Replacing the speedometer cable .....	6
Temperature gauge, testing and removing the sensor unit .....	6
Replacing the temperature gauge dial .....	6
Windscreen wiper, replacing the wiper blades	6

### Group 94, Heater system

Description .....	7
Heater, early production .....	7
Heater, late production .....	8
Heater control valve .....	8
Repair instructions	
Heater, early production .....	10
Heater, late production .....	10
Replacing the heater controls .....	11
Replacing the warm air tunnel .....	11
Specifications .....	12

## GROUP 91 INSTRUMENTS

### DESCRIPTION

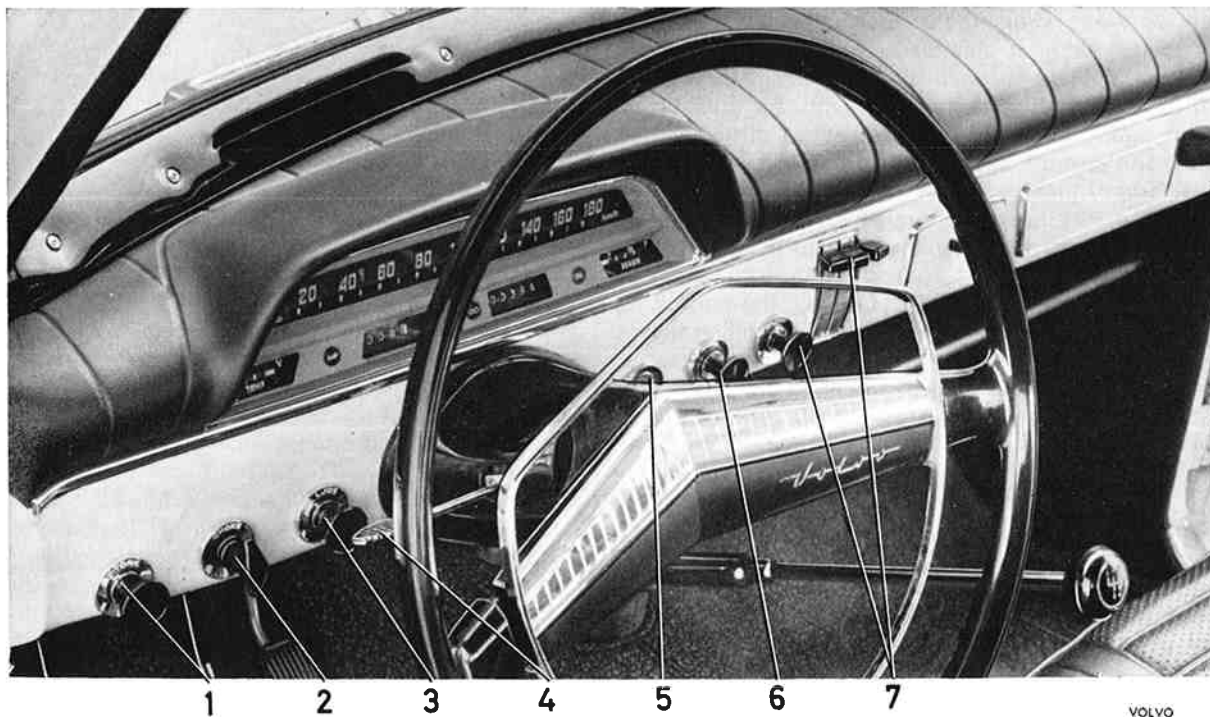

Fig. 1. Instruments and controls

1. Control for windscreen wiper and washer
2. Choke control
3. Lighting switch
4. Direction indicator switch with headlight flasher
5. Ignition switch with starter contact
6. Cigarette lighter
7. Controls for heater and ventilation system

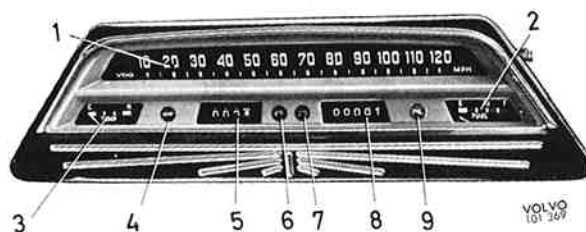

Fig. 2. Combined instrument, front side

### COMBINED INSTRUMENT

The combined instrument incorporates the speedometer, temperature gauge, fuel gauge, four warning lamps and two instrument lighting bulbs. The combined instrument is illustrated in Fig. 2 and 3.

1. Speedometer
2. Fuel gauge
3. Temperature gauge
4. Charging control lamp
5. Trip meter
6. Warning lamp for full-beam headlights
7. Warning lamp for direction indicators
8. Mileometer
9. Warning lamp for oil pressure
10. Instrument lighting

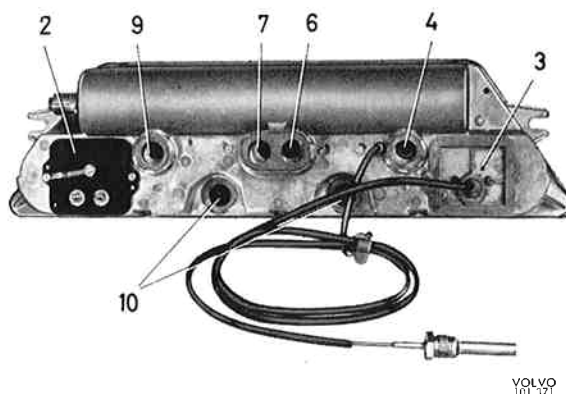
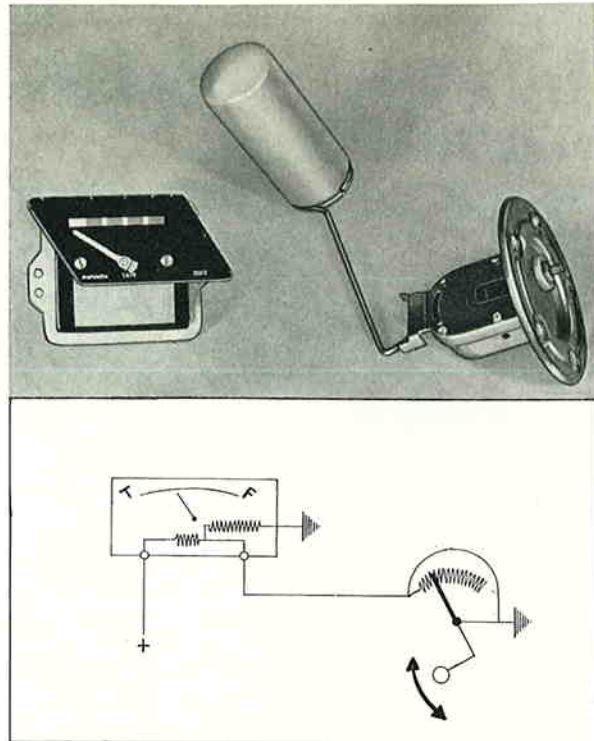

Fig. 3. Combined instrument, reverse side

**FUEL GAUGE**

The fuel gauge has two main parts. These consist of the tank fitting and the actual dial on the instrument panel. The tank fitting consists of a float which, through a lever, is connected with a contact arm which slides over an electrical resistor (rheostat). Any alteration of the fuel level in the tank will cause either a smaller or larger part of the resistor windings to be in circuit. The instrument dial has two coils, one in series with the rheostat in the tank fitting, and one connected directly to earth. The current can therefore flow in two directions. One of these is through the series-connected coil of the instrument, through the rheostat of the tank fitting to earth (alternative 1) and the other is through the coil which is connected to earth (alternative 2). When the fuel tank is empty, the current flows as described in alternative 1. When filling the tank, the current flowing in this way will be reduced due to an increasing part of the rheostat coming into circuit, so that a larger part of the current will flow through it directly to the coil connected to earth (alternative 2). The pointer on the dial will then move from the "Empty" position it had in alternative 1 and will give a reading on the scale proportional to the amount of fuel filled in the tank. When the dial shows "Empty", the float of the tank fitting should be about 1.5 cm ( $\frac{5}{8}$ " ) from the bottom of the tank.



VOLVO  
101 372

Fig. 4. Fuel gauge

**SPEEDOMETER**

The speedometer is of the eddy current type. It is driven through the speedometer cable by a worm gear on the output shaft of the gearbox. When the speedometer driving cable begins to rotate, it carries with it a ring-shaped permanent magnet which is placed on the right side of the speedometer roller. The rotational speed of the magnet will thus be the same as that of the driving cable. On the left side of the speedometer roller there is a torsion spring, the purpose of which is to brake the roller, at the same time tending to move the roller to the 0-position. A magnetic field exists between the permanent magnet and the right-hand end of the speedometer roller. There are also lines

of magnetic force between the magnet and the ring which surrounds the permanent magnet at a certain distance.

This space is intended for the ring-shaped and projecting part of the speedometer roller, see Fig. 5. When driving, varying magnetic fields will arise which, when passing over the projecting part of the speedometer roller, will give rise to eddy currents. The torsional effect which both the magnetic field and the induced eddy currents will have on the speedometer roller depend partly on the speed and partly on the opposing force of the torsion spring.

1. Torsion spring
2. Stop arm for speedometer roller
3. Dial scale
4. Speedometer roller
5. Ring for magnetic lines of force and induced eddy currents
6. Permanent magnet
7. Worm gear for driving mileometer

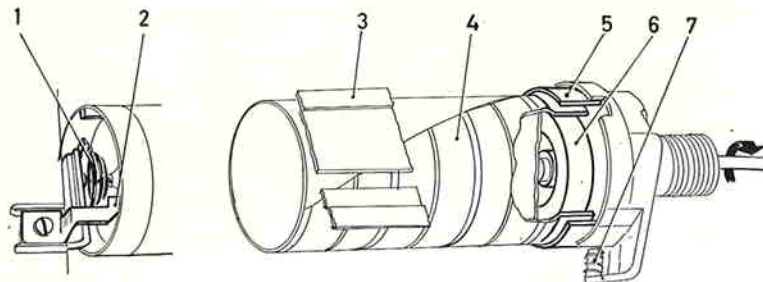

Fig. 5. Construction of the speedometer

VOLVO  
101 373

The mileometer and trip meter are driven from the speedometer shaft. Fig. 6 shows how the numeral rollers of these meters are driven.

The drive ratios from the speedometer to the mileometer and trip meter are worked out by the manufacturer so that the speedometer cable makes 0.63 of a revolution per metre driven. This value is also stamped on the reverse of the instrument.

Concerning percentage error with different tyre sizes, see the "Specifications" on page 12.

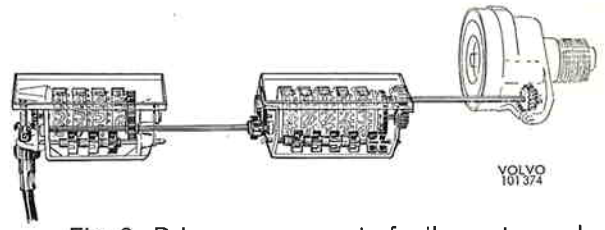

Fig. 6. Drive arrangement of mileometer and trip meter

**TEMPERATURE GAUGE**

The temperature gauge consists of a sensor unit and a dial. These are connected to each other by means of a copper pipe with a very small internal diameter. In order to protect it from external damage and to prevent sharp bends, the pipe is provided with a pleated protective covering and, on late production vehicles, an additional plastic covering. The sensor unit consists of a small container. It is partly filled with a mixture of volatile liquids, principally consisting of ether. As the coolant temperature rises, this liquid is progressively transformed into gas. This gives rise to an increase in pressure, which is transmitted through the above-mentioned copper pipe up to the flat tubular spring in the temperature gauge dial. The spring then tends to straighten itself out and at the same time transmits a movement to the lever which, through a suitable reduction, actuates the pointer of the instrument.

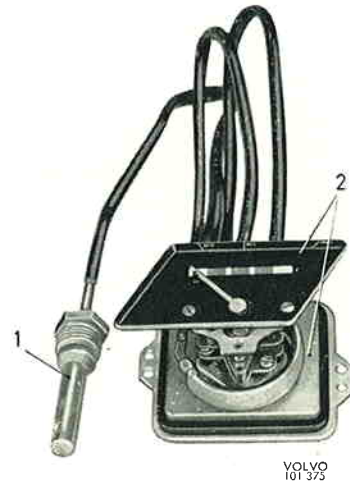

Fig. 7. Temperature gauge

- 1. Sensor unit
- 2. Dial unit

**OIL PRESSURE CONTACT**

The function of the oil pressure contact is shown in Fig. 8. The contact is adjusted to a predetermined breaking pressure. When the engine oil pressure is above this value, the oil pressure warning lamp is out.

In the right-hand part of Fig. 8, the oil pressure is so low that the spring overcomes the force operating on the other side of the diaphragm. The contact rivet is then pressed down against the contact plate, with the result that the warning lamp lights. The adjusting screw of the contact, by means of which the breaking pressure can be varied, is accessible by removing the pipe on the oil pressure contact. Any adjustment of the breaking pressure must not, however, be done unless the engine oil pressure is measured at the same time with a separate pressure gauge.

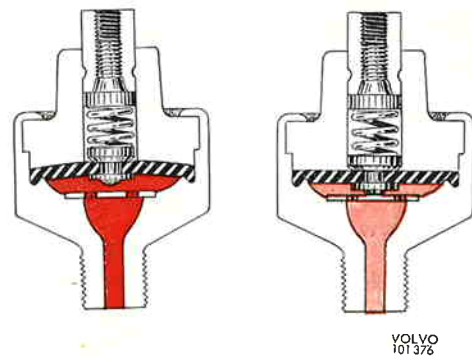

Fig. 8. Function of oil pressure contact

Engine	Breaking pressure
B 18	0.6—1.0 kg/cm <sup>2</sup> (8.5—14 lb/sq.in.)
B 16	0.6—1.0 kg/cm <sup>2</sup> (8.5—14 lb/sq.in.)

## WINDSCREEN WIPER

The windscreen wiper is driven by an electric motor. The motor is connected to the wiper blades through a drive gear housing and link arms. The motor has two speeds, which can be selected by means of the pull-switch on the instrument panel. The windscreen is self-parking. Concerning removing, lubricating and adjusting the wiper motor, drive gears and linkage, see Part 3 (36).

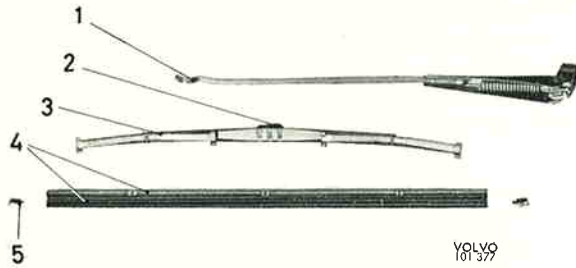

Fig. 9. Wiper arm and blade assembly

1. Wiper arm
2. Retaining spring
3. Scraper fitting
4. Rubber blade and retainer
5. Retaining piece

# REPAIR INSTRUCTIONS

## REPLACING THE COMBINED INSTRUMENT

Before removing or fitting the combined instrument, one of the battery connections must **always** be removed from the battery, preferably the pleated earth lead.

When removing the combined instrument, the bulb holders for the warning lamps and instrument lighting are removed first. Then disconnect the speedometer cable and leads to the fuel gauge. The temperature gauge should be removed from the instrument if it is not necessary to remove the combined instrument complete. It is simpler to do this than to drain the coolant and remove the sensor unit from the cylinder head, see under "Removing the temperature gauge". Remove the nuts which hold the combined instrument to the instrument panel. Lift out the instrument.

When replacing the individual instruments, see under the headings concerned.

## FUEL GAUGE

Before removing any component belonging to the fuel gauge, the fault should first be localized as described below.

Check that the lead terminals for the dial are properly tight. Switch on the ignition. With a voltmeter or test lamp, check to see that there is voltage on the feed side of the instrument. When this has been done, continue testing as follows.

### Instrument shows "Empty"

1. Disconnect the lead terminal on the tank fitting and hold the lead away from the vehicle frame. Switch on the ignition. The fuel gauge should then show "Full".
2. If the instrument shows "Empty", disconnect the lead on the instrument (the lead which connects the dial to the tank fitting). If the dial

now shows "Full", there is nothing wrong with the instrument and the fault will either be in the actual tank fitting or in the connecting lead to the instrument dial.

### Instrument shows "Full"

1. Disconnect the lead terminal on the tank fitting. Switch on the ignition.
2. Earth the lead connected to the tank fitting with the help of a test lead. If the pointer goes over to "Empty", the lead and dial are undamaged. The fault is to be found in the tank fitting.
3. If, when carrying out these tests, the pointer does not go over to "Empty", also disconnect the lead at the terminal on the instrument. Earth the contact screw by means of a test lead. If the instrument is undamaged, the pointer should then go over to "Empty". Otherwise the fault is due either to poor contact on the terminals between the instrument and lead to the tank fitting or a breakage in the lead. A faulty instrument or tank fitting should be replaced with new parts.

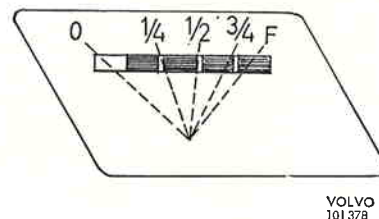

Fig. 10. Guiding values for the instrument dial scale

**Replacing the fuel gauge**

1. Disconnect the plated earth lead from the battery.
2. In order to facilitate removing the dial, first unscrew both the attaching screws of the ignition switch. Then bend the ignition switch out of the way.
3. Mark and disconnect the leads from the instrument. Remove the attaching screws and carefully lift out the instrument.

**Fitting**

1. Place the instrument dial in position and tighten the attaching screws.
2. Connect up the leads in accordance with the marking previously made. Do not confuse the leads!
3. Place the ignition switch in position and tighten the attaching screws.

**Replacing the tank fitting**

1. Make sure that the ignition key is in the switched-off position.
2. Turn back the mat in the luggage compartment and lift off the tank fitting cover plate.
3. Blow well clean round the tank fitting with compressed air.
4. Disconnect the lead and remove the screws which hold the tank fitting and then lift it out.

**Fitting**

Always use a new gasket in order to prevent leakage and petrol fumes inside the vehicle.

1. The gasket should be coated on both sides with a sealing adhesive which does not affect rubber and which is not dissolved by petrol.
2. Place the gasket in position on the tank. Place the tank fitting in position and tighten the screws well. Connect the lead.

**SPEEDOMETER**

In order to correct any faults, the special tools and instructions used by a VDO authorized workshop should be available. If such special tools and instructions are not available, any adjustment and checking of the speedometer should be carried out by an authorized instrument workshop.

**Checking the speedometer cable**

It is most important that the speedometer cable should be fitted correctly in order for the speedometer to function without trouble. The following should therefore be observed. At no point must the bending radius of the speedometer cable be less than 100 mm (4"). In order to facilitate checking this, it is advisable to manufacture a template with a bending radius of 100 mm (4") as shown in Fig. 12. Note also that late production speedometer cables and instruments are provided with a guide at the connecting points, see the arrows on Fig. 14.

Concerning replacement of speedometer gears, see Part 4 (43) and the specifications on page 12.

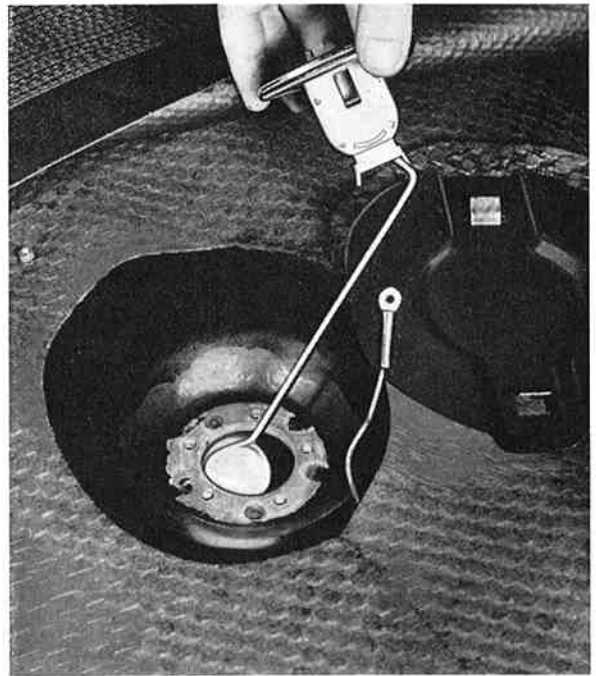

VOLVO 101 379

Fig. 11. Removing the tank fitting

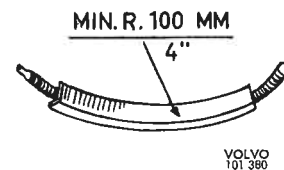

VOLVO 101 380

Fig. 12 Template for fitting speedometer cable

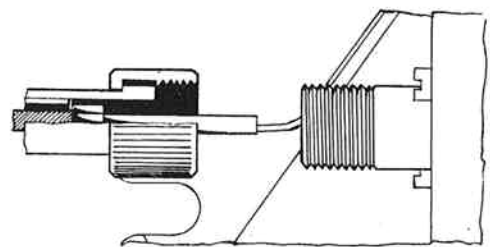

VOLVO 101 381

Fig. 13. Speedometer cable connection, early production

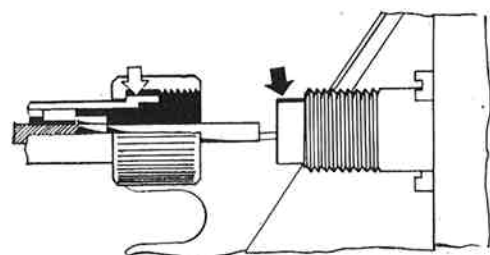

VOLVO 101 382

Fig. 14. Speedometer cable connection, late production

**Replacing the complete speedometer cable**

1. Screw off the cap nut on the instrument. Remove the rubber grommet from the cowl wall and pull the cable through.
2. Release the necessary retaining clips and unscrew the cap nut on the gearbox connection.
3. When fitting the new speedometer cable, handle it in such a way that there is no risk of damaging the driving cable or outer covering. When replacing a complete speedometer cable, no extra lubrication of the driving cable is normally necessary.
4. Thread the speedometer cable through the rubber grommet.
5. Connect the speedometer cable both to the instrument and gearbox.
6. Fit the rubber grommet in position. Fit the necessary retaining clips and make sure that the bending radius at any point is not less than that permitted, see under "Checking the speedometer".

**TEMPERATURE GAUGE**

**Testing the temperature gauge and removing the sensor unit**

If any fault is suspected in the temperature gauge, carry out the following check before removing it.

1. Drain sufficient coolant from the system so that the sensor unit comes above the coolant level.
2. Remove the sensor unit from the cylinder head. If it is stubborn, carefully prise it backwards and forwards. Be careful with the gauge pipe.
3. Immerse the sensor unit in a container filled with hot water. An ordinary and previously checked mercury thermometer is used for making comparative readings. In order to obtain good measuring results, both the sensor unit and thermometer should be prevented from coming into contact with the bottom of the container. It is not usually worthwhile to repair the temperature gauge.

**Removing the temperature gauge dial**

1. Disconnect the pleated earth lead from the battery.
2. Remove the screws which hold the instrument dial and lift it out
3. Remove the rubber grommet from the cowl and pull through the sensor unit. Be careful not to make sharp bends in the delicate measuring pipe.

**Fitting**

1. Push the sensor unit through the cowl wall.
2. Place the instrument dial in position in the combined instrument. Avoid sharp bends in the measuring pipe. Tighten the retaining screws.
3. Fit the sensor unit in the cylinder head. Fit the rubber grommet in the cowl wall.
4. Fill up with coolant. Check the level after starting the engine and top up if necessary.

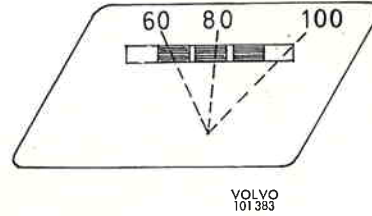

Fig. 15. Guiding values in °C for the temperature gauge scale.

**WINDSCREEN WIPER**

The ability of the windscreen wiper blades to keep the windscreen free from asphalt, gravel and insect splashes becomes successively reduced. Additional factors are the severe operating conditions during winter and the natural ageing of the material. The wiper blades must therefore be regarded as replacement items. When replacing the wiper blades, the spring pressure of the scrapers should also be checked. In order to obtain good results, any silicon deposits or traffic film on the windscreen glass should be removed with a suitable window cleaning agent. Be careful when doing this, as most such agents can damage the paintwork.

**Replacing the wiper blades**

1. Release the scraper by lightly moving the retaining spring.
2. Take out one of the retaining pieces and remove the rubber blade and its retainer from the scraper fitting.
3. Fit the new wiper blades. Use new retaining pieces.
4. Moisten the windscreen when testing the wiper blades. Check the contact of the blades with the glass. Also make sure that the blades are adjusted so that they do not strike against the windscreen frame. Check this with the wiper motor running at full speed.

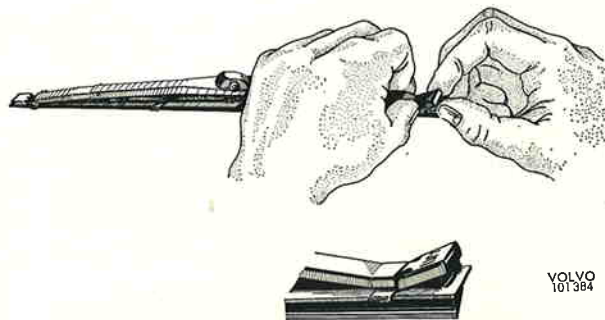

Fig. 16. Replacing wiper blade.



# GROUP 94 HEATER SYSTEM

## DESCRIPTION

Early production

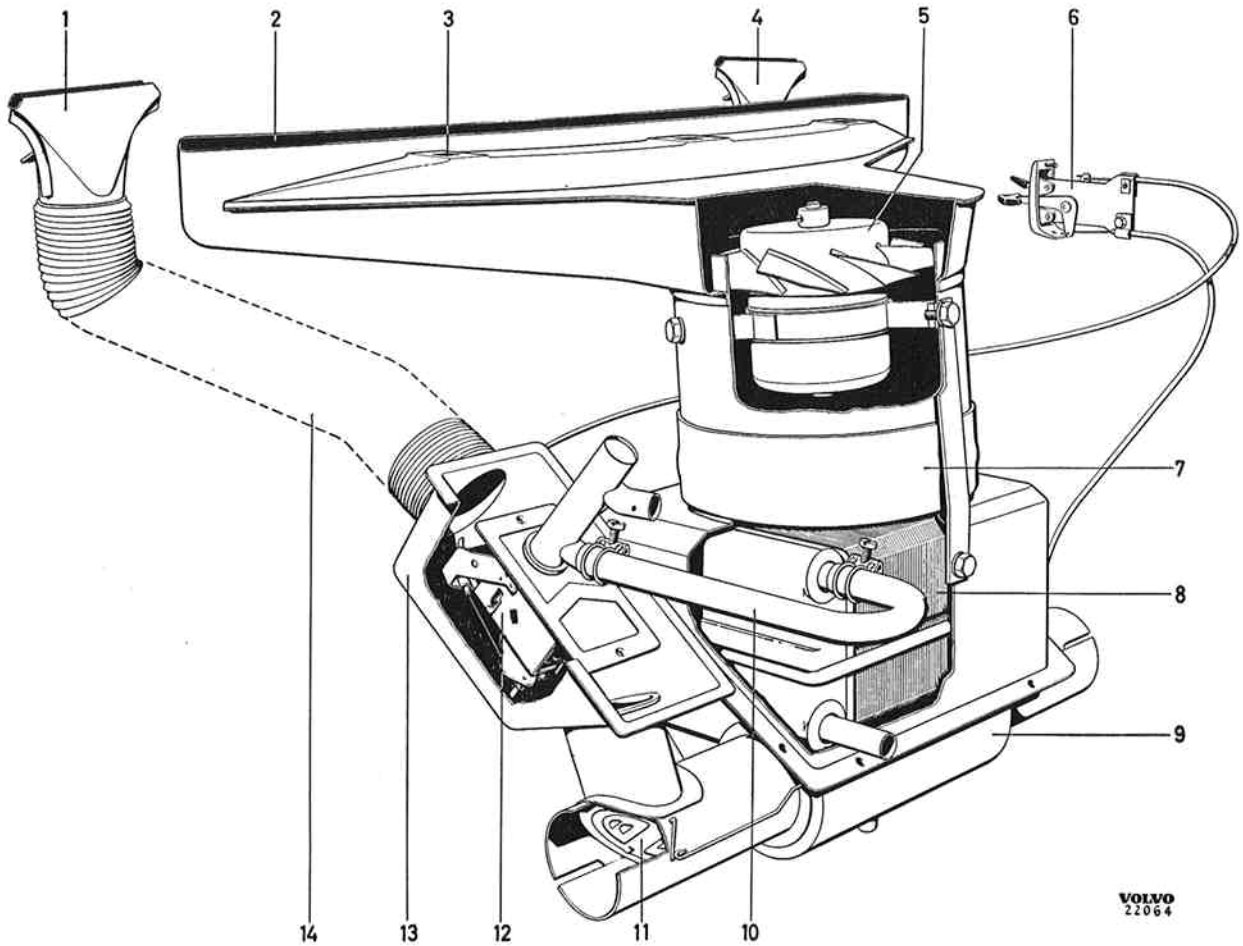

Fig. 17. Heater.

1. Defroster nozzle
2. Air intake
3. Nut for attaching bolt
4. Defroster nozzle
5. Fan motor
6. Controls
7. Rubber gaiter
8. Cell system
9. Distribution housing
10. Rubber hose
11. Shutter
12. Heater control valve
13. Casing
14. Spiral reinforced hose

Late production

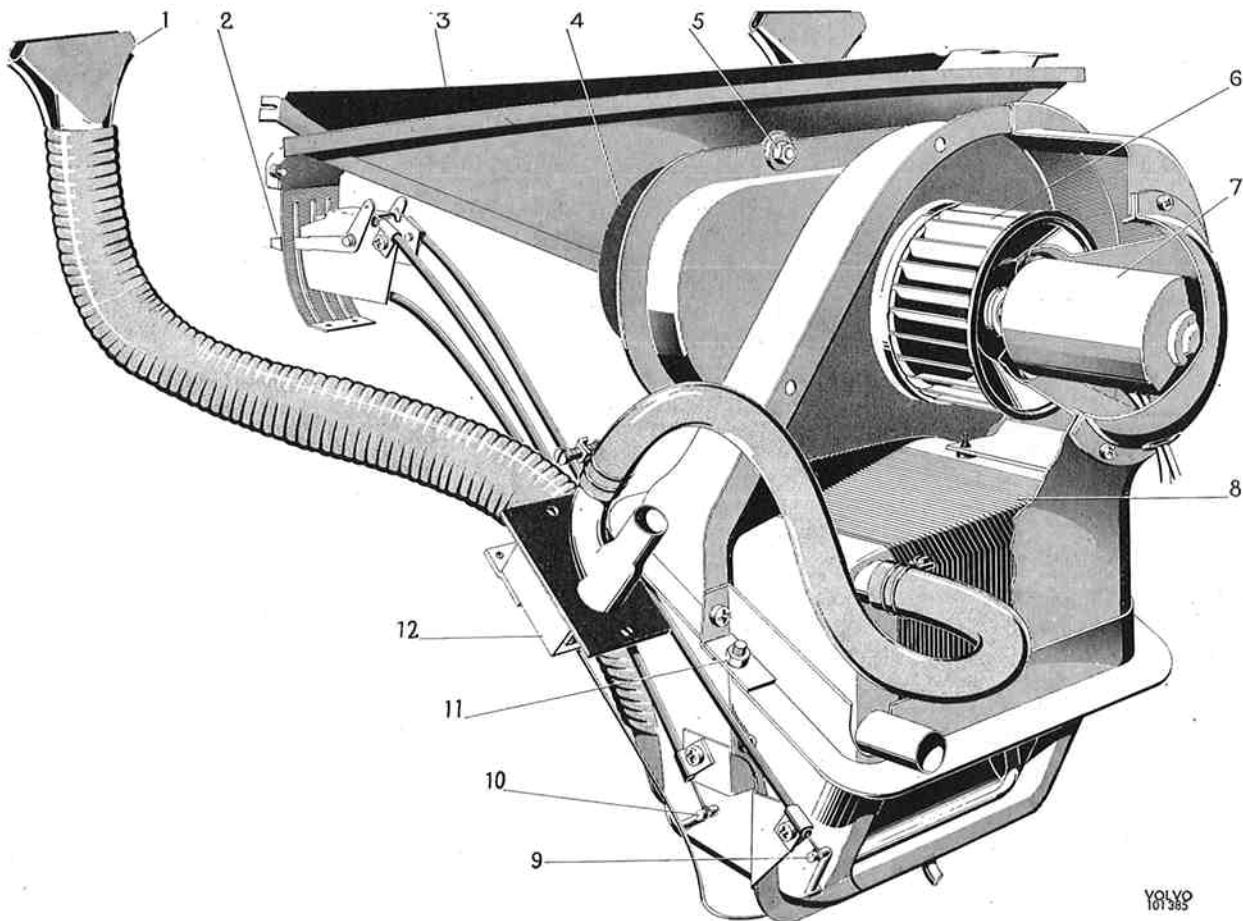

Fig. 18. Heater.

- |                     |                                     |
|---------------------|-------------------------------------|
| 1. Defroster nozzle | 7. Electric motor                   |
| 2. Controls         | 8. Cell system                      |
| 3. Air intake       | 9. Shutter lever for outgoing air   |
| 4. Rubber gasket    | 10. Shutter lever for defroster air |
| 5. Attaching bolt   | 11. Attaching bolt                  |
| 6. Fan rotor        | 12. Heater control valve            |

The heater illustrated above consists of the following main parts: air intake (welded to the body), water separator, fan housing with fan and motor, cell system, distribution housing including shutters, heater control valve and controls.

Fig. 19 shows the flow of the cold air and hot air respectively to the defroster and space around the feet when the fan is switched on and the shutters are fully open.

### HEATER CONTROL VALVE

The heater control valve is one of the main parts of the heater. The purpose of the valve is to control the supply of heated coolant to the cell system of the heater. This supply is controlled by the valve in two ways; both manually by means of the heater control and automatically through a thermostat arrangement. The function of the heater control valve is shown in Fig 21.