

VOLVO

INSTRUKTIONSBOK
INSTRUKTIONSBOK
INSTRUKTIONSBOK
INSTRUKTIONSBOK
BETRIEBSANLEITUNG
LIVRO DE INSTRUÇÕES
LIBRO DE INSTRUCCIONES
MANUEL D'INSTRUCTIONS
INSTRUKTIONSBOK
INSTRUKTIONSBOG
INSTRUKSJONSBOK
INSTRUKTIEBOEKJE
INSTRUCTION BOOK
BETRIEBSANLEITUNG
LIVRO DE INSTRUÇÕES
LIBRO DE INSTRUCCIONES
MANUEL D'INSTRUCTIONS
INSTRUKTIONSBOK
INSTRUKTIONSBOG
INSTRUKSJONSBOK
INSTRUKTIEBOEKJE
INSTRUCTION BOOK
BETRIEBSANLEITUNG
LIVRO DE INSTRUÇÕES
LIBRO DE INSTRUCCIONES
MANUEL D'INSTRUCTIONS
INSTRUKTIONSBOK
INSTRUKTIONSBOG
INSTRUKSJONSBOK
INSTRUKTIEBOEKJE
INSTRUCTION BOOK
BETRIEBSANLEITUNG
LIVRO DE INSTRUÇÕES
LIBRO DE INSTRUCCIONES
MANUEL D'INSTRUCTIONS
INSTRUKTIONSBOK
INSTRUKTIONSBOG
INSTRUKSJONSBOK
INSTRUKTIEBOEKJE
INSTRUCTION BOOK
BETRIEBSANLEITUNG
LIVRO DE INSTRUÇÕES
LIBRO DE INSTRUCCIONES
MANUEL D'INSTRUCTIONS



120

VOLVO 120

2-DOOR

CARS

(120S)

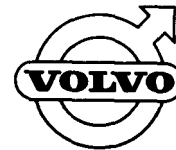

DESCRIPTION

OPERATING INSTRUCTIONS

SERVICING

AB VOLVO GOTEBOG SWEDEN

Service

Cables: Volvo, Goteborg, Sweden

Reprinting permitted if source quoted

BEFORE YOU START DRIVING YOUR NEW VOLVO PLEASE READ THROUGH THIS INSTRUCTION BOOK CAREFULLY. IT CONTAINS ALL THE INFORMATION YOU NEED TO BE ABLE TO DRIVE AND SERVICE YOUR VEHICLE IN THE BEST POSSIBLE WAY. BY FOLLOWING THE INSTRUCTIONS GIVEN IN THIS BOOK, YOU WILL FIND THAT YOUR VOLVO WILL COME UP TO ALL THE EXPECTATIONS CONCERNING ECONOMICAL OPERATION AND EXCELLENT PERFORMANCE THAT YOU HAVE EVERY RIGHT TO EXPECT OF A TOP-QUALITY VEHICLE. DO NOT WAIT UNTIL SOMETHING GOES WRONG BEFORE YOU START READING THIS BOOK. READ IT NOW. THE SHORT TIME THIS TAKES WILL MORE THAN REPAY YOU IN THE LONG RUN. THIS INSTRUCTION BOOK IS NOT INTENDED TO BE A COMPREHENSIVE TECHNICAL MANUAL AND DOES NOT CLAIM TO MAKE THE READER INTO A PERFECT CAR MECHANIC. IT WILL, HOWEVER, SHOW YOU HOW TO LOOK AFTER YOUR VEHICLE SO THAT TROUBLE IN FUTURE CAN BE AVOIDED. FOR MORE DETAILED OPERATING INSTRUCTIONS AND ADJUSTMENTS, YOU ARE REFERRED TO THE SPECIAL SERVICE MANUAL FOR THE VEHICLE.

AB VOLVO

VOLVO SERVICE	Page
The Volvo Service Organization	4
Warranty and Service Booklet	5
Service Inspections	5

DESCRIPTION	page
Type designations	6
Engine	8
Electrical system	9
Power transmission	10
Brakes	11
Wheels and tyres	11
Body	12
Instruments and controls	16

OPERATING INSTRUCTIONS	page
Running-in	22
Starting the engine	23
Gear-changing	24
Points worth noting	25

SERVICING	page
General	27
Maintenance scheme	28
Lubrication	30
Engine	34
Electrical system	39
Power transmission	43
Brakes	43
Front end	43
Wheels and tyres	44
Body	46
Servicing before long-distance trip	49
Procedure in cold weather	50
Lubricating chart	60

FAULT TRACING	Page 52
----------------------	----------------

SPECIFICATIONS	page 53
-----------------------	----------------



Volvo Service Organization

In order to get the most out of the invested capital represented by a car, it must be looked after and serviced regularly. Volvo has gone to a great deal of trouble in the design and selection of material to ensure that the car in question only requires a minimum of servicing. All this work will be in vain unless we can count on your co-operation - that is to say, that you make sure that your vehicle gets the regular servicing it needs. In order to help you, Volvo has built up a world-wide service organization. All Volvo dealers have specially trained personnel and receive a continuous supply of technical information from the Volvo Service Organization concerning repairs and adjustment work. They have also special tools, designed at the Volvo factory.

All Volvo dealers have a comprehensive stock of spare parts which is your guarantee for genuine Volvo spares. This is why our dealers are in the very best position to give your vehicle first-class service concerning both maintenance operations and repairs. You should also refer to your dealer if you need information about your Volvo that is not included in this instruction book.

Not only in your own country is there a Volvo workshop within easy reach. Volvo also has a widely distributed service network in other countries.

Warranty and Service Booklet

A warranty and service booklet accompanies each vehicle when it is delivered. This book contains a coupon entitling you to a free service inspection after 2 500 km (1 500 miles) running. If possible, let the dealer who supplied the vehicle carry out this service inspection. If necessary, however, any of our dealers can do this.

If our six-month guarantee is to apply, we make one absolute condition and that is that the above-mentioned cost-free inspection is carried out at roughly the mileage shown and that the vehicle has been looked after in accordance with the instructions in this book.

Service Inspections

After the cost-free service inspection has been carried out, you should make an agreement with your dealer concerning continued, *regular* service inspections in accordance with the suggestions made in our *Service Book*. *Thorough and regular servicing is of vital importance for the performance and length of life of the vehicle.*

Always use genuine Volvo spares.

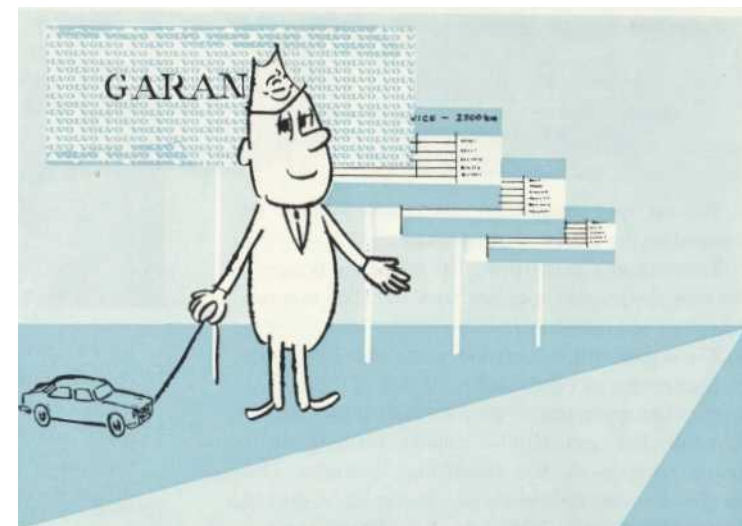

DESCRIPTION

Type designations



This instruction book deals with cars having the following type designations (note that certain variations are not to be found on certain markets):

Type designation	Engine	Gearbox
13-134	B 20 A	M 40
13-334	B 20 B	M 40
13-194	B 20 A	M 40
13-394	B 20 B	M 40
13-344	B 20 B	M 40

1. The car type designation and chassis number are stamped on the cowl under the bonnet.

2. Stamped on a plate to the left under the bonnet is the type designation together with the code numbers for colour and upholstery.

3. The engine type designation, part number and serial number are given on the left-hand side of the cylinder block. The last figures of the part number are stamped on a tab. The serial number follows this with all the figures stamped on. For identifying the engine, both the part number and serial number should be quoted, for example 496918-3456.

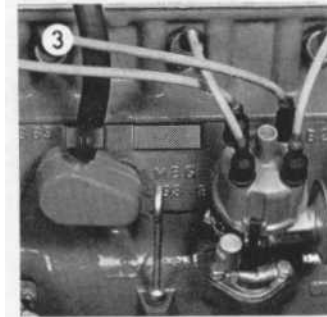
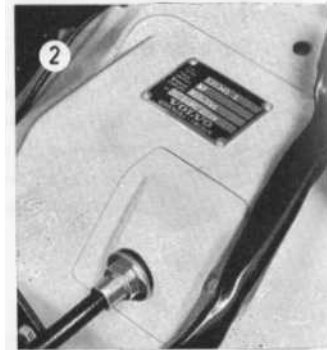
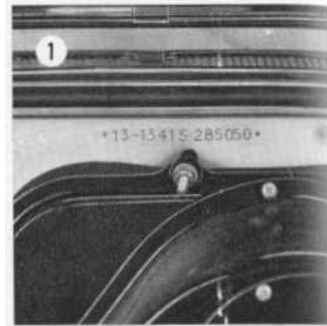

In all correspondence concerning your vehicle with the dealer and when ordering spare parts, the *type designation, chassis and engine number* should always be quoted.

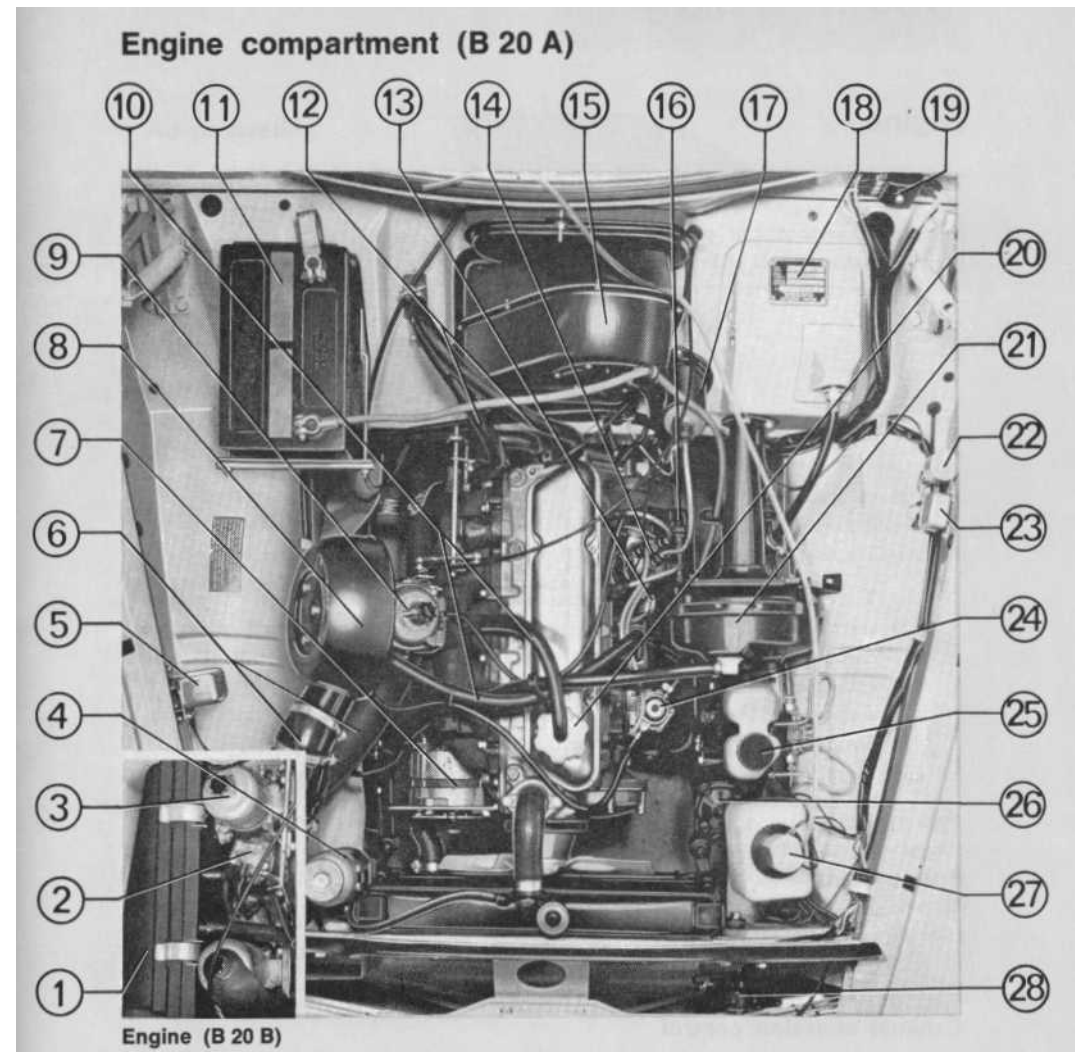

- | | | |
|-----------------------------------------------|----------------------------------------------------|---------------------------------|
| 1. Air cleaner (B 20 B) | 0. Hoses for positive crankcase ventilation | and upholstery |
| 2. Floatchamber (B 20 B) | 1. Battery | 19. Fusebox |
| 3. Carburettors (B 20 B) | 2. Hoses for heater system | 20. Oil filler cap |
| 4. Expansion tank with filler cap for coolant | 3. Oil dipstick | 21. Brake servo cylinder |
| 5. Voltage regulator | 4. Distributor | 22. Relay for reversing lights |
| 6. Hoses for air preheating | 5. Car heater | 23. Relay for headlight flasher |
| 7. Alternator | 6. Starter motor | 24. Fuel pump |
| 8. Air cleaner (B 20 A) | 7. Ignition coil | 25. Brake fluid container |
| 9. Carburettor (B 20 A) | 8. Plate with type designation and code for colour | 26. Steering box |
| | | 27. Windscreen wipers |
| | | 28. Horn |

Engine

The engine is a four-cylinder carburettor unit with overhead valves. The pistons are made of light-alloy and the upper compression rings on each piston are chromed. The main bearing and big-end bearing shells are replaceable. The crankshaft is statically and dynamically balanced.

Engine type B 20 A has an output of 90 h.p. (SAE) and is equipped with a Zenith-Stromberg horizontal carburettor.

Engine type B 20 B has an output of 118 h.p. (SAE) and is equipped with twin SU horizontal carburettors. (On certain markets twin Zenith-Stromberg horizontal carburettors.)

Fuel system

Fuel is fed from the tank to the carburettor by a fuel pump which is driven by a cam on the engine camshaft. There is a filter in the fuel pump which traps water and other impurities in the fuel.

Exhaust emission control

The engine is fitted with exhaust emission control, that is, a system as a result of better mixing and distributing of fuel and air provides a more complete combustion and thereby cleaner exhaust gases. On the B 20 A engine, the exhaust emission control is obtained through the carburettor which is specially designed for this purpose. On the B 20 B engine the exhaust emission control is provided partly through carburettors specially designed for this purpose and partly by the engine having a special induction manifold with throttles and preheating chamber. When driving at low speeds the throttles are closed so that the fuel-air mixture is forced to pass the preheating chamber.

When higher output is required, the throttles open so that the fuel-air mixture flows directly to the cylinders.

Air preheating

Certain variations of the 120 models are provided with thermostatically controlled air preheating.

With this arrangement the induced air is maintained at a constant, favourable temperature. Air preheating counteracts ice formation in the carburettor and also contributes to a shorter warming up period after starting from cold.

Lubricating system

The engine lubrication is taken care of by a gear pump which sucks up oil from the sump on the bottom of the engine and forces it through the oil filter out to the lubricating points in the engine. A relief valve is built into the oil filter which prevents the oil pressure from reaching excessively high values.

Cooling system

The engine is water-cooled and the cooling system is of the pressure type. Water is circulated by means of a pump fitted on the fan shaft. A wax-type thermostat with an opening temperature of about 82°C (180°F) prevents the cooling water from passing through the radiator before the engine has reached its normal working temperature. On certain markets a fan with a slip-type coupling is fitted.

Electrical system

The electrical system is of the 12-volt type and is fitted with a voltage-regulated alternator. The starter motor is operated from the instrument panel by the ignition key, which also switches on the rest of the electrical system. The cables to the headlights, parking lights and internal lighting, however, are not taken over the ignition switch but can be switched on and off without the ignition key being in position.

DESCRIPTION

Lighting

The lighting on the car consists of two headlights (mainbeam and dipped) together with two combined flasher and parking lights. The rear lighting consists of two tail lights including flashers, combined lamps for the tail lights and brake warning lights as well as the reversing light.

Internal lighting consists of a roof light above the rear view mirror and a light for the parcel shelf.

See pages 40-42 concerning replacement of bulbs.

Fuses

The electrical system is protected by means of fuses fitted in a fusebox to the left on the bulkhead under the bonnet. When replacing a fuse, be sure that you use one with the right rating. If any fuse should blow repeatedly, do not fit a more powerful fuse. Instead, have a workshop check the electrical system.

Power transmission

Clutch

The clutch is of the single dry plate type with diaphragm spring. The diaphragm spring functions partly as a lever when declutching and partly as a pressure spring when engaging. Clutch pedal pressure is transmitted mechanically to the release fork.

Gearbox

The gearbox is used to regulate the speed ratio between the engine and the rear axle so that the engine always operates in its most favourable speed range. The gearboxes are fully synchronized. The M 40 gearbox is four-speed.

DESCRIPTION

Propeller shaft

The propeller shaft, which is the connecting link between the gearbox and the rear axle, is divided into two sections. The front section is journalled at its rear end in a bearing housing consisting of a rubberized ring.

Rear axle

The engine driving power is transmitted via the propeller shaft to the rear wheels through the rear axle. The rear axle is of the hypoid type, that is, the drive pinion is below the centre line of the drive shafts.

On certain markets, the rear axle is fitted with a differential brake as extra equipment. The function of the differential brake is to transfer automatically the pulling power to the wheel with the best grip on the road surface when one of the wheels begins to skid. Except for the differential, the rear axle is similar to a conventional rear axle.

Brakes

The brake system is of the two-circuit type with disc brakes front and drum brakes rear. The system is provided with a tandem-type master cylinder and a directly-operating booster cylinder.

The principle of the two-circuit system is that both front wheels are connected to a rear wheel. Should there be a failure in one of the circuits there is always braking power on both front wheels and the other rear wheel. The pressure lines to the rear wheels are fitted with relief valves which prevent involuntary locking of the rear wheels.

This system has a warning light located on the instrument panel. The warning light shows if there is a failure in one of the circuits when braking. It also serves as a warning light for the handbrake.

Wheels and tyres

The car has pressed steel wheels with lugs for the attachment of the hub caps. All wheels are carefully balanced and the tyres are of the tubeless type. Tyre size: 165 S 15, or 165 SR 15.

DESCRIPTION

Body

Bonnet

O The bonnet is fitted with a locking catch which is operated from the driving seat by means of a handle located to the left under the dashboard. Pulling out the handle releases the bonnet.

O When the bonnet locking catch has been released, the bonnet is still retained by a safety catch. Press up this catch as shown in the picture opposite and the bonnet can be lifted up. Closing the bonnet locks it so that it can only be opened by pulling out the release handle. Always make sure that the bonnet locks properly when closed.

Luggage compartment

O The luggage compartment is locked with the same key as that used for the doors. The lid is opened by pressing the handle upwards as shown in the picture opposite. The lid is balanced and will thus remain in the position opened. To the left of the luggage compartment there is space sufficient for the spare wheel and a tool kit. Always make sure that the spare wheel is fastened securely and that the tool kit is firmly stowed, otherwise irritating rattles can occur.

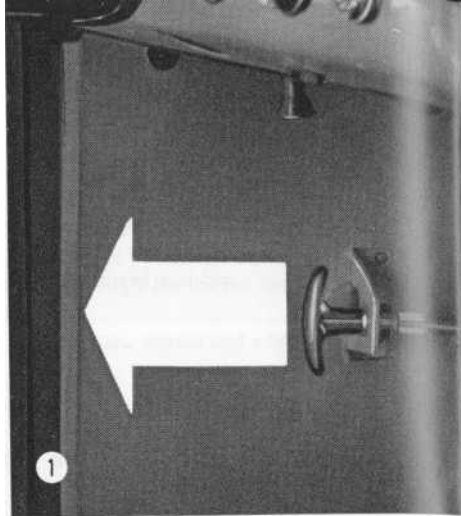

Doors and locks

O Both the doors are fitted with a lock and keyhole.

Both doors can be locked from inside the car by pressing down the lock buttons on the window ledge. The lock button lifts automatically when the door is opened from the inside. The doors can be locked from the outside by pressing the lock button on the window ledge and shutting the door. *Do not leave the keys in the car.*

O The doors are opened from the inside by turning the door handle to the rear. The ventilation windows for the door are opened by unscrewing the lock stud, pressing it in and then turning the handle upwards. Screwing in the stud locks the handle.

O The rear side windows can be partially opened by setting the handle at the rear edge in different positions.

To prevent the locks from freezing up in cold weather, apply a suitable anti-freeze agent. If the locks are already frozen, do not exert undue force on the key otherwise you might break it. Instead, heat it with a match or similar and place it quickly in the keyhole.

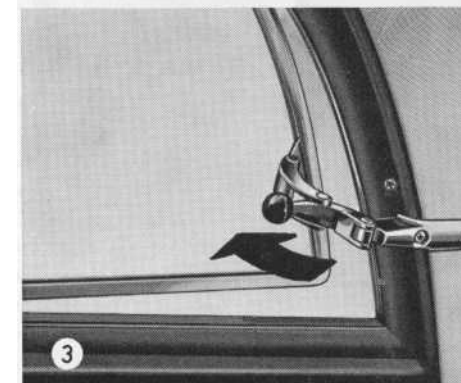
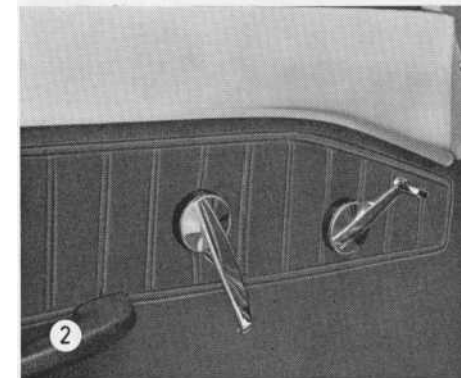
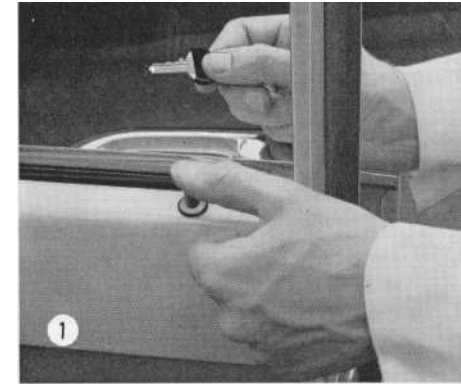

Should you lose the car keys, contact your nearest Volvo dealer for new keys and quote the code number of the keys which have been lost.

DESCRIPTION

Front seats

- The front seats can be moved backwards or forwards after the knob (A) is pressed down. If necessary, the seats can be moved further to the rear than permitted by the slide rail by using the extra holes in the seat frames.

The backrest inclination of the front seats is smoothly adjusted by means of a knob (B) on the outside of the seat. A catch automatically locks the backrest and thus prevents it from falling forwards. To fold the backrest backwards, release the catch (C).

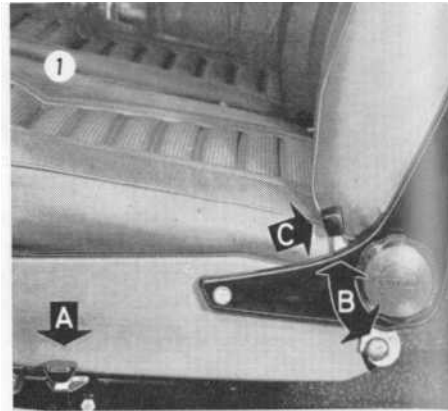

- The front seats are also provided with an adjustable lumbar support. To tension the lumbar support, and thus exert more pressure against the small of the back, turn the knob clockwise. Turning it anti-clockwise slackens the tension on the support and reduces the pressure against the small of the back.

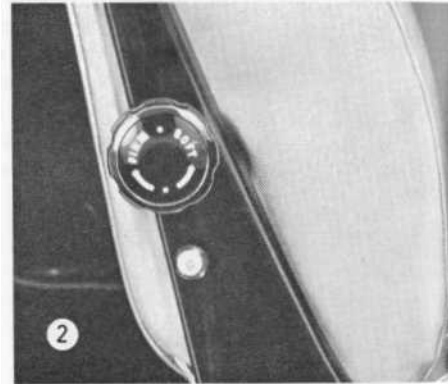

- The inclination angle of the entire seat can be adjusted with the eyelet screw at the front under the seat. Remove the screw which goes through the eyelet and tip the seat backwards as shown in the picture. Then slacken the locknut on the floor and screw the eyelet screw upwards or downwards to the desired height. Then secure the eyelet screw with the locknut.

The whole seat can be raised or lowered, which is done as follows: Remove the seat cushion, also the screw and nut on the seat frame attachment on the floor. Then place the screw in one of the other holes in the attaching bracket.

The front seat backrests have built-in attachments for mounting a headrest.



Safety belts

- Always use the safety belt when driving. Remember that even when driving slowly in city traffic, serious injury can arise from sudden, unexpected stopping. The practical design of the belt makes it very easy to use. Place one strap across the lap and the other over the shoulder and breast and lock the belt by inserting the buckle tongue into the locking device between the front seats. A loud clicking noise indicates that the belt is locked.

Make sure that the parts of the belt in contact with the body are not twisted. Always ensure that the belt is so adjusted that it fits well against the body.

- If the belt requires lengthening, take hold of the adjusting piece with one hand and with the other hand pull out to the desired length the lower part of the double section of the lap strap.

- If the belt is to be shortened, pull in the upper part of the lap strap. After a certain amount of practice, all belt adjustment can be carried out with the one hand. The belt is released from the locking device by moving to the rear the lever concerned on the locking device. Do not let the belt lie on the floor otherwise it will become dirty and probably be a hindrance when getting in and out of the car. Now and again check that the bolts anchoring the belt are properly tightened and that the belt is in good condition. Use water mixed with a synthetic washing agent for cleaning the belt.

As the safety belts lose much of their strength when exposed to violent stretching, they should be replaced after a collision, even though they may appear to be undamaged. Never modify or repair the belt on your own but have this done by a Volvo workshop.

Rear seat

As standard, the rear seat has anchorages for safety belts. On certain markets, safety belts are also fitted to the rear seat.



DESCRIPTION

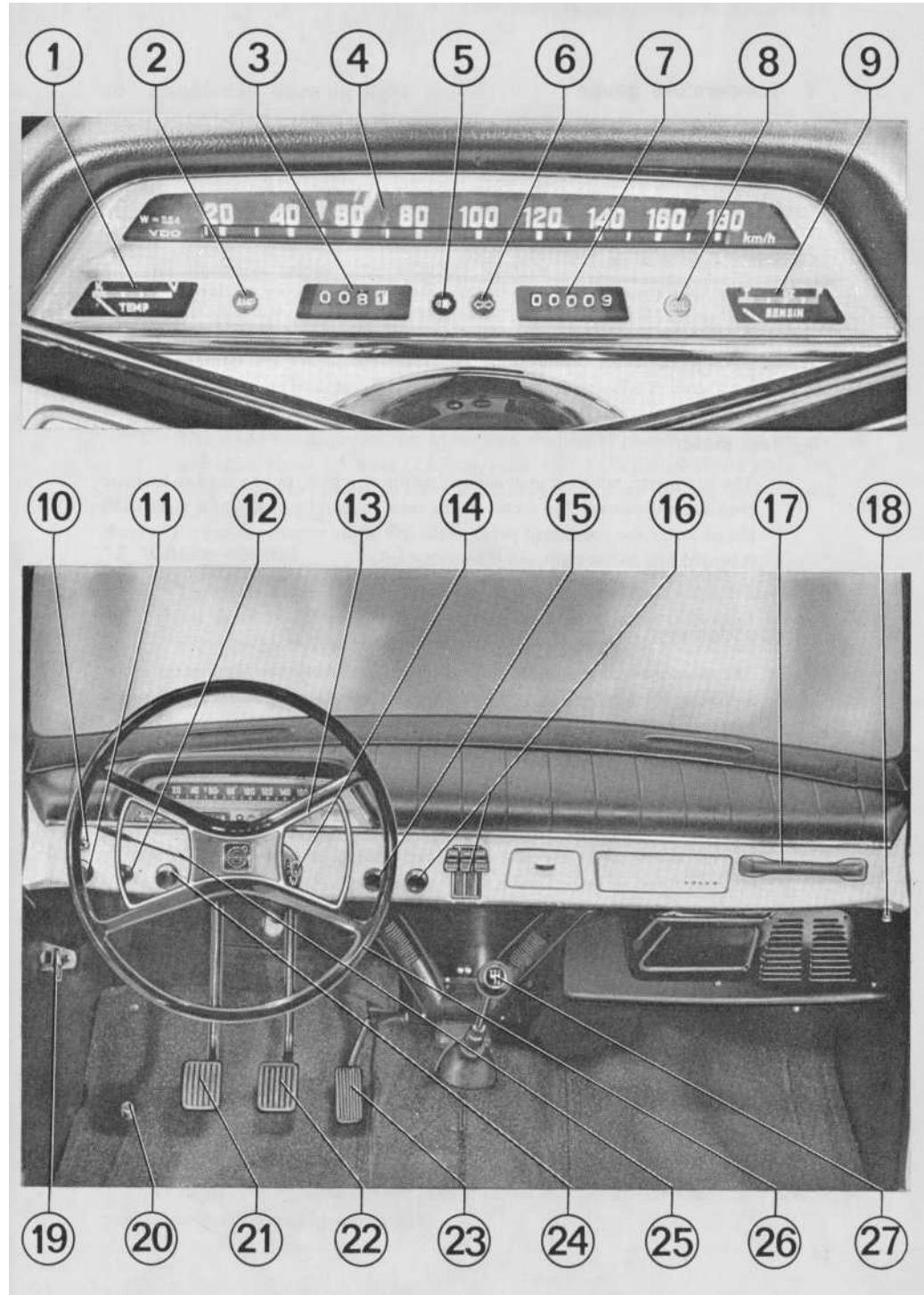

Instruments and controls

Before you start the car, sit behind the wheel and carefully check through all the instruments and controls. The location of these is shown in the illustration opposite. The instruments and controls are described in more detail on the following pages with reference to the numbers in the illustration. Note that variations may occur on different markets.

Immediately after starting, and now and then while driving, glance at the instruments to make sure they are showing normal readings according to the values given in the following text.

- | | |
|---------------------------------------------|--------------------------------------------------|
| 1. Temperature gauge | 15. Cigarette lighter |
| 2. Warning light, battery charging | 16. Fan switch, heater/ventilation controls |
| 3. Trip meter | 17. Grab handle |
| 4. Speedometer | 18. Switch for glove compartment light |
| 5. Mainbeam control light | 19. Bonnet release handle |
| 6. Direction indicator control light | 20. Foot dipper switch |
| 7. Milometer | 21. Clutch pedal |
| 8. Oil pressure warning light | 22. Brake pedal |
| 9. Fuel gauge | 23. Accelerator pedal |
| 10. Warning lamp, handbrake, brake system | 24. Lighting switch |
| 11. Windscreen wiper and washer switch | 25. Director indicator, switch headlight flasher |
| 12. Choke control | 26. Steering wheel |
| 13. Horn ring | 27. Gear lever |
| 14. Ignition switch and steering wheel lock | |

DESCRIPTION

1 Temperature gauge

The temperature gauge shows the temperature of the coolant and thus indicates the working temperature of the engine. The pointer on this gauge should remain within the green sectors.

2 Battery charging warning light

This light goes on when the battery discharges. If it goes on during driving, this means either that there is some fault in the electrical system or that the fan belt is not sufficiently tensioned and is thus slipping on the pulley, causing poor charging.

3 Trip meter

The trip meter, which is graduated in tenths of a mile, can be used to measure even short distances. The meter can be reset to zero by means of a reset knob placed under the instrument panel to the left of the steering column. The knob is turned first to the right and then to the left.

4 Speedometer

The speedometer has a horizontal red ribbon indicator, the ribbon point showing the speed at which you are travelling. Since the length of the red ribbon is proportional to the speed, this is in itself a safety factor - the more red shown, the more dangerous your speed.

7 Milometer

The milometer shows the total distance covered in miles. After 99 999 miles it returns to zero and starts going round again.

8 Oil pressure warning light

This light goes on when the engine oil pressure is too low. When the ignition is switched on, the light should go on and then go out again when the engine has been started. *Never start driving until the light goes out.* Should the light remain on during driving, the engine should be stopped and the cause for this determined. In most cases it means that the oil level is too low. After hard driving it may happen that the warning light comes on when the engine is at idling speed. This is normal providing it goes out again when the engine speed is increased.

DESCRIPTION

10 Handbrake warning light

This lights red when the handbrake is applied and the ignition is on.

The light also functions as a warning light should a failure arise in one of the brake service circuits. If the light goes on when driving, the car should be taken without delay to a workshop for a check on the brake system. Observe due care when driving on such occasions.

11 Windscreen wiper and washer switch

The windscreen wiper and washer switch has four positions. When pressed fully in, the switch is switched off. When the switch is pulled out to the first position, the windscreen wipers operate at normal speed. When it is pulled out to the second position, the wipers operate more quickly. Pulling the switch out fully also operates the windscreen washers.

The liquid container for the windscreen washers is placed under the bonnet and holds about 1.5 litres (2.6 Imp. pints = 3.2 US pints). Never allow the wiper blades to operate on a dry and dusty surface since this can easily scratch the glass and blades.

12 Choke control

The choke control is used when the engine is started from cold. When pulled out about 10-15 mm ($\frac{1}{2}$ ") the control operates the throttle flap and increases idling speed. Pulling the control out further, enriches the fuel-air mixture, and this steps up the idling speed.

14 Combined ignition switch and steering wheel lock

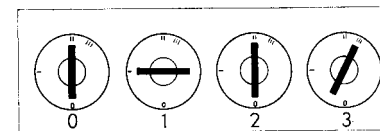

The switch has four positions: (0) Locking position, (1) Garage position, (2) Driving position and (3) Starting position. The key can only be inserted or taken out of the lock in the Locking or Garage position. Removing the key when in the Locking position automatically locks the steering wheel.

If the key is removed from the lock in the Garage position, the electrical system is disconnected, except for the radio. The steering wheel is not locked.

During driving, the key should be in the Driving position.

To start the engine, turn the key to the Starting position and this automatically engages the starter motor. As soon as the engine starts, release the key which automatically returns to the Driving position.

If the car is parked in such a way as to make it difficult to unlock the steering wheel, unlocking can be made easier by slightly turning the steering wheel one way and then the other.

15 Cigarette lighter

To use the cigarette lighter, push it in. As soon as it attains sufficient heat, it will automatically spring out.

DESCRIPTION

16 Heater and ventilation system

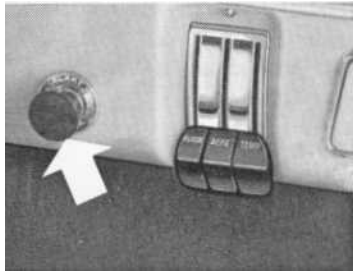

Fresh-air fan switch
Pushed right in - closed
Interm. pos. - full output
Fully out - half output

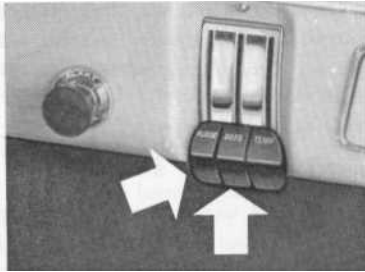

Air flow
FLOOR - - Air to front seat floor
DEFR = Air to windscreen and to rear seat floor

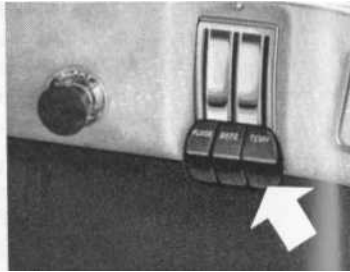

Air temp.
This control is used to regulate the temperature of the incoming air.

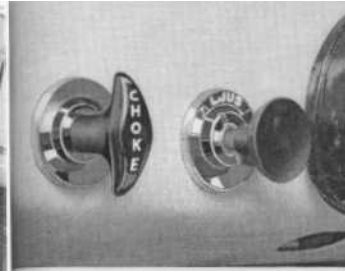

Parking lights
(Lighting switch pulled out one notch)

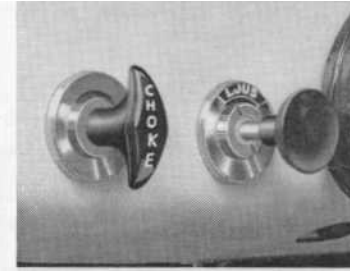

Dipped headlights
(Lighting switch fully out and foot dipper switch in dipped position)

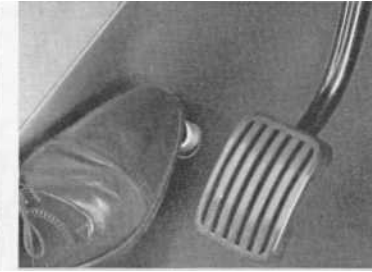

Mainbeam
(Lighting switch out fully and foot dipper switch in mainbeam position)

The heating and ventilation system of the car is operated as shown above. Air is sucked in by the fan and then passes through a heater element to a distributing chamber where it is distributed to the floor and windscreen by means of the controls. **NOTE:** Under normal conditions there is sufficient air-flow due to the fact of the overpressure at the air inlet of the vehicle. If greater quantities of air are required, use the fan.

The heater element is connected with a thermostat which keeps the temperature constant. When the temperature control is moved, there will be a slight delay before the heater element adjusts itself to the desired temperature.

The illustration shows the air duct to the rear seat and the air distribution in the vehicle when both the "FLOOR" and "DEFR" controls are used.

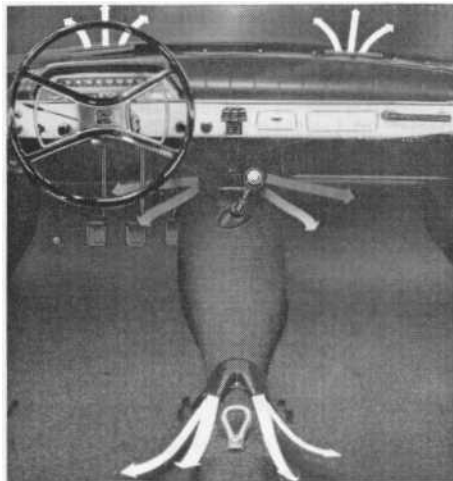

During cold or damp weather mist can easily form on the windows, particularly with a full number of passengers. The best way of getting rid of this or to avoid it altogether is to open the ventilation windows partly or fully and to set the fan and defroster controls at max. output.

Panel light switch

The panel light switch is regulated by rotating the small lighting switch knob.

Warning signal flashers

On certain markets, the car is fitted with warning signal flashers which are operated by pulling out the switch next to the heater controls.

25 Direction indicator switch lever

The direction indicators are controlled by means of the switch lever mounted on the left-hand side of the steering column under the steering wheel.

Interior lighting

1. The light goes on when the front doors are opened.
2. The light is off all the time.
3. The light is on all the time.

Mainbeam flasher

Moving the direction indicator switch up towards the steering wheel switches on the mainbeam lighting which remains on until the switch lever is released.

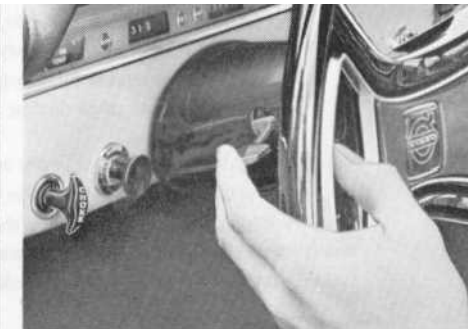

Running-in

As the car is new, we recommend that a certain amount of caution be observed during the running-in period, for it is during this time that the movable parts of the car must be properly bedded in so as to obtain smooth and durable sliding surfaces. Do not drive at full engine output for more than short periods during the first 500 km (300 miles) and avoid labouring in all gears.

Warranty inspection

After 2 500 km (1500 miles) running, the car should be taken to a Volvo workshop for the free warranty inspection. The procedure then carried out also includes an engine oil change. It is very important to ensure that this oil change is carried out since during the first period the engine oil usually collects a lot of impurities.

After 5 000 km (3 000 miles) running, the oil in the gearbox and rear axle should be changed. Subsequent changes should be carried out at approximately those intervals indicated in the maintenance scheme on page 28 and in the lubricating chart at the end of the book.

Before being delivered, Volvo engines are test-run on test benches and in the cars on test tracks. We are therefore assured that all clearances are satisfactory and thus accept no responsibility for damage caused by careless running-in.

Starting the engine

Starting a cold engine

1. Check that the handbrake is on and the gear lever is in neutral.
2. Pull the choke control out fully.
3. Depress the clutch pedal to assist when starting especially in cold weather.
4. Turn the ignition key to the starting position. Release the key as soon as the engine has started.
5. Push in the choke control until the best idling speed is obtained. As the engine becomes warmer push in the control more and more but never so far that the engine starts to run unevenly. Drive for as short a period as possible with the choke out. With the air preheating arrangement, the engine runs smoothly already some minutes after starting. When the engine is thoroughly warm, the controls should be pushed right in.

After starting a cold engine, do not race it immediately but run it at moderate speed and do not subject it to heavy loading until engine temperature has reached normal level.

Starting a warm engine

1. Check that the handbrake is on and the gear lever is in neutral.
2. Depress the clutch pedal.
3. Turn the ignition key to the starting position. Release the key as soon as the engine has started. If the engine does not start immediately, depress the accelerator pedal fully and hold it there until the engine has started.

Warming up the engine

Experience has shown that engines in vehicles which are frequently stopped and started are subject to abnormally rapid wear. The reason for this is that the engine is not given a chance to reach its normal working temperature. When the engine is cold, it should be taken up to its normal working temperature as quickly as possible. Do not therefore idle the engine too long but start driving with a light load on the engine as soon as the oil pressure light goes out.

**Recommended speed ranges, km.p.h. (m.p.h.)
for the different gears**

Engine	Gearbox	1st gear	2nd gear	3rd gear	4th gear
B 20 A	M 40	0-45 (0-28)	15-70 (10-45)	25-100 (15-60)	35- (22-)
B 20 B	M 40	0-50 (0-30)	20-80 (15-50)	30-115 (20-70)	40- (25-)

**Points worth noting
Starting in a garage**

If you start your car in a garage, always open the garage doors before starting the engine. The exhaust gases from the engine contain poisonous carbon monoxide gas which is particularly dangerous since it is both invisible and odourless.

Gear-changing

The gearbox has synchromesh on all forward gears. If this is to function satisfactorily, the clutch pedal must be fully depressed.

To obtain good acceleration, it is important that the gear-change timing is adapted to the speed in such a way that the engine speed is within suitable limits, neither too high nor too low.

The gear positions are shown in the picture opposite.

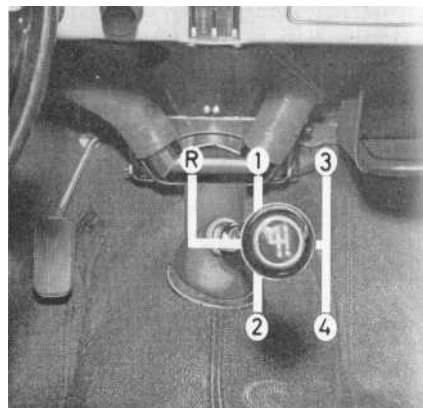

Gear positions for 4-speed gearbox

Driving with the luggage compartment lid open

While driving with the luggage compartment lid partly or fully open, exhaust gases (and consequently also carbon monoxide) can be sucked into the car through the luggage compartment, particularly if a window is open. Normally this involves no risk to the passengers. However, on such occasions, the following advice should be followed:

1. Keep all windows closed.
2. Set the fresh air and defroster levers to fully open and the fan control to full speed.

Braking

Steady acceleration and gentle braking are characteristic of a good driver and also result in the most economic running. Apply the brakes *before* going into a curve and use your gearbox on downhill gradients so that you save unnecessary wear on both brakes and tyres.

Violent braking is only justified in dangerous situations.

Towing

If the car is to be towed, the tow line should not be attached directly to the bumpers, but should be taken round the bumper supports as shown in the picture opposite. While the car is being towed, the tow line should be kept evenly stretched since violent jerks can damage the bumpers.

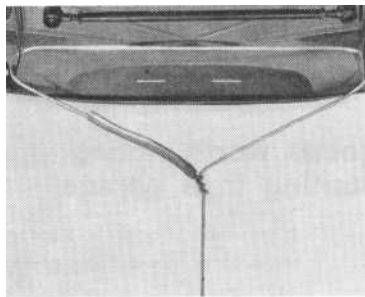

General

Before the car was delivered from the factory it was subjected to a very thorough inspection. Your dealer, in his turn, carried out a further delivery inspection in accordance with the specifications of the Volvo factory. In addition to this there is the free service inspection after 2 500 km (1 500 miles). Subsequent servicing of the car should follow the routine in the *service book* which is based on a system involving an oil change, oil level check and service inspections after every 10 000 km (6 000 miles).

The simplest (and in the long run most profitable) way to give the car the servicing it requires is to have all servicing done by a Volvo workshop. You will then have all the work specified in the service book carried out in accordance with recommended prices and the workshop stamp in the service book will show when the car was serviced - this is also extremely important as far as second-hand value is concerned.

During the designing of the car, particular attention was given to the "safety details" (e.g. suspension, brakes and steering). They are calculated to withstand the severest stresses with a wide safety margin. However, if you use your car for hard driving, you should take the precaution of checking these parts for fatigue cracks sometime during the car's useful life, for instance when the parts concerned are reconditioned.

If you prefer to carry out the simpler servicing procedures yourself or if you are sometimes obliged to have them done by a workshop outside the Volvo organization, this chapter contains some advice as to when and how they should be carried out.

For the sake of convenience, the servicing procedures have been summarized in a maintenance scheme in the next two pages.

Maintenance scheme

In the maintenance scheme below the servicing procedures have been given certain numbers which refer to the detailed descriptions on the following pages. Some of the work must be carried out by skilled mechanics or requires the use of special tools and these have been marked D.

Operation	Carried out every:		See note below
	10 000 km 6 000 miles	20 000 km 12 500 miles	
Lubrication			
1 Lubricate body	●		● Once a year
2 Check oil level in engine			● When filling up with fuel
3 Change oil in engine	● ¹⁾		● See page 31
4 Carburettors, filling oil in the damping cylinders	●		
5 Check oil level in gearbox	●		
6 Change oil in the gearbox			● 40 000 km ²⁾ (25 000 miles)
7 Check oil level in rear axle	●		● ³⁾
8 Change oil level in rear axle			
9 Check oil level in rear axle, with the differential brake	●		
10 Change oil in the rear axle with differential brake			● ³⁾
11 Check oil level in steering box	●		
12 Check brake fluid level			● When filling up with fuel
Engine			
13 Servicing of crankcase ventilation			● 40 000 km (25 000 miles)
14 Replace oil filter	□		
15 Clean fuel filter	●		
16 Change air cleaner B 20 A			● 40 000 km (25 000 miles)
17 Change air cleaners B 20 B			● 40 000 km (25 000 miles)
18 Clean foam plastic sleeve, air cleaner		● ⁴⁾	
19 Check valve clearances	□		
20 Carry out compression test	□		
21 Check fan belt	□		

- 1) Also after the first 2 500 km (1 500 miles) during running-in.
 2) Only after first 5 000 km (3 000 miles).
 3) After every 80 000 km (50 000 miles) the paper filter should be replaced.
 4) Also after the first 5 000 km (3 000 miles) during running-in.

In addition to the servicing procedures mentioned in this scheme, you should also regularly check the following from the point of view of traffic safety:

- Lighting, including brake warning light
- Direction indicator lights
- Horn

Operation	Carried out every		See note below
	10 000 km 6 000 miles	20 000 km 12 500 miles	
22 Check coolant level			● When filling up with fuel
23 Change coolant			● Every other year
24 Check sparking plugs	□		
25 Change sparking plugs		□	
26 Check distributor contact breakers	□		
27 Check ignition timing	□		
Electrical system			
28 Check electrolyte level in battery			● Every other week
29 Check state of charge of battery	□		
30 Check headlight alignment	□		
Power transmission			
31 Check clutch yoke travel	□		
32 Check propeller shaft	□		□ Once a year
Brakes			
33 Check and overhaul brakes	□		
34 Replace booster cylinder air filter			□ 40 000 km (25 000 miles)
Front end			
35 Check front wheel alignment	□		□ Once a year
36 Check ball joints, tie-rods, etc.	□		□ Once a year
Wheels and tyres			
37 Check the air pressure			● Every other week
Body			
38 Washing			See page 46
39 Polishing			See page 46
40 Anti-rust treatment			See page 48
41 Cleaning			See page 48

Lubrication

Chassis maintenance

To simplify maintenance of your Volvo, the vehicle has been equipped with ball joints, steering rods and propeller shaft of such a design that they do not require regular lubrication. This has been possible due to the fact that points which normally require lubricating have been packed with very durable grease at the factory and then carefully sealed, thus obviating the need for lubrication. However, in order to be certain that these parts are functioning properly, it is necessary to inspect their seals and rubber sleeves thoroughly after every 10 000 km (6 000 miles) or at least once a year.

Oil should be changed or the oil level checked after every 10 000 km (6 000 miles) in accordance with the lubricating chart at the end of the book. This can be done in connection with the 10 000 km (6 000 miles) inspection at a Volvo workshop. The measures taken during this inspection are also to be found in the lubricating chart.

You should follow the recommendations of the Service Booklet, which are based on Volvo's own investigations. Use only first-class lubricants of a well-known make. The *right* lubricant in the *right* quantity at the *right* time will increase both the lifetime and reliability of your car.

1 Body lubrication

In order to avoid squeaks and unnecessary wear, the body should be lubricated about every 10 000 km (6 000 miles) or at least once a year. During very cold weather the door locks and luggage compartment lock should be treated with a suitable anti-freeze agent to prevent them from freezing up.

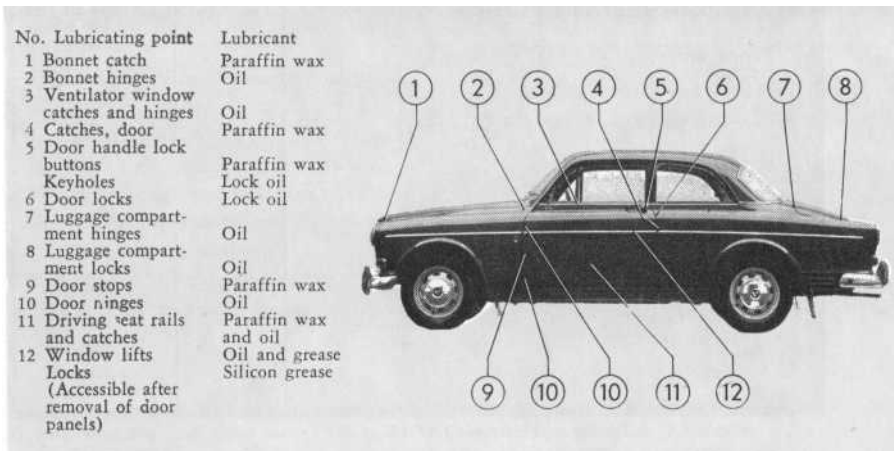

2 Check the oil level in the engine

The oil level in the engine should be checked each time the fuel tank is filled. The check should be carried out with the engine switched off but warm and, in order to obtain comparable values, about 1 minute after the engine has been stopped. Wipe the dipstick before measuring. The oil level should be between the two marks on the dipstick. It must never be permitted to go down below the lower mark but on the other hand, it should not be above the upper mark since oil consumption will then be abnormally high. If necessary, top up by filling through the oil filler hole on the rocker arm casing with new oil of the same type already in the engine.

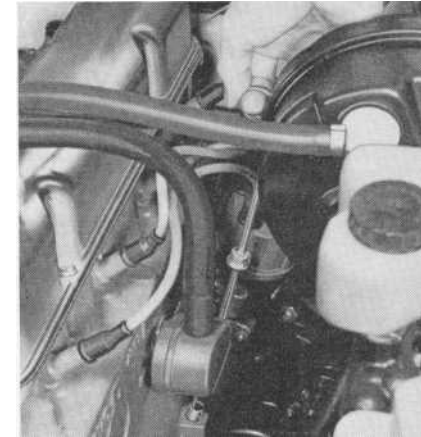

3 Changing the engine oil

With a new or reconditioned engine, the oil should be changed after the first 2 500 km (1 500 miles). Subsequent oil changing is according to the intervals given below.

The intervals will depend to a great extent on the type of oil used. For engine lubrication, oil grade "For Service MS", is to be used. As far as viscosity is concerned, *multigrade* oil is recommended. These oils are better suited for demanding driving conditions, for example continuous driving in city traffic with incessant stopping and starting or with lengthy idling periods.

For engine oil with viscosity SAE 10 W - 30 (multigrade), 10 w-40 or 20 W-50, the oil should be changed every 10 000 km (6 000 miles) or at least once a year.

If engine oil with viscosity SAE 10 W (singlegrade), 20/20 W or 30 is used, the oil should be changed every 5 000 km (3 000 miles), or at least twice a year.

At very low temperature (below -20°C = -4°F) multigrade oil SAE 5 W-20 is recommended. However, this oil should not be used when the temperature is continuously above 0°C (32°F).

Viscosity Oil grade	Temperature range	Oil change intervals km (miles)*	Oil capacities
SAE 10 W-30 10 W-40 20 W-50 "For Service MS"	all year round	10 000 (6 000) or at least once a year	No oil filter 3.25 litres (5.72 Imp.pints = 6.86 US pints)
SAE 10 W 20/20 W 30	below -10°C (14°F) between -10°C and +30°C (14 and 90°F) above 30°C (90°F) "For Service MS"	5 000 (3 000) or at least twice a year	With oil filter 3.75 litres (6.60 Imp.pints = 7.91 US pints)

*) Change the oil after the first 2 500 km (1 500 miles) during running-in.

4 Carburettor(s)

The old oil is drained off by removing the drain plug on the sump. Draining should take place after driving when the oil is still warm.

For lengthy motorway driving fuel with an octane rating of 97 (ROT*) can also be used for the B 20 B engine.

At each engine oil change, check that the oil level in the centre spindle of the carburettor(s) is about 6 mm ($\frac{1}{4}$ ") from the top of the spindle. If it is not, top up to the level using oil ATF, type A (transmission oil).

The carburettors are adjusted and tested in a test bench at the factory with a CO-meter. No subsequent checking or setting of the carburettors is necessary other than in connection with repairs to or replacement of the carburettors.

* Research Method

5 Gearbox, M 40

- 6 The oil in the gearbox should be checked after every 10 000 km (6 000 miles). The oil should be at the level of the filler hole. Top up with the recommended oil if necessary. The oil in the gearbox should be changed after every 40 000 km (25 000 miles). In the case of a new or reconditioned gearbox, the oil should be changed after the first 5000 km (3 000 miles), on which occasion the gearbox should be thoroughly flushed with oil of the same type to be subsequently used. The old oil should be drained off immediately after the vehicle has been run when the oil is still warm.

Oil grade

Gear oil
alt.

Engine oil

Viscosity

SAE 80
At temperatures continuously
below +30°C (90°F),
SAE 90

SAE 30 alt.
SAE 20 W-40

Oil capacity

0.75 litre
1.3 Imp. pints
1.6 U. S. pints

7 Rear axle

- 8 The oil level in the rear axle should be checked after every 10 000 km (6 000 miles). The oil should be up to the level of the filler hole. Top up with the recommended oil if necessary.

The oil in the rear axle should be changed after the first 5 000 km (3 000 miles), and should also be flushed thoroughly with the same type of oil used for topping up. The used oil should be drained off immediately after the vehicle has been run, when the oil is still warm.

After this oil change, only the oil level need be checked and topping up take place if necessary.

Oil grade

Hypoid oil

Viscosity

SAE 90. Continuously below
-10°C (14°F), SAE 80

Oil capacity

1.3 litres
2.3 Imp. pints
2.7 U. S. pints

9 Rear axle with differential brake

- 10 A rear axle fitted with differential brake is filled at the factory with transmission oil according to the American military standard MIL-L-2105 B provided with an additive for rear axles with differential brake. The same type of oil should be used for topping up and when changing. Oil level checking and changing should take place at the same intervals and in the same way as for a rear axle without differential brake.

SERVICING

11 Steering box

The oil level in the steering box should be checked after every 10 000 km (6 000 miles). The oil should be at the level of the filler plug. If necessary, top up with the recommended oil. The oil in the steering box generally does not need to be changed except when reconditioning takes place. If the oil is to be changed, the old oil can be sucked up by means of an oil syringe or similar, which is inserted down through the filler hole.

Oil grade	Viscosity	Oil capacity
Hypoid oil	SAE 80 (all year round)	0.25 litre 0. i-i Imp. pint 0.53 U. S. pint

12 Brake fluid

The brake fluid level in the brake hydraulic system should be checked after every 5 000 km (3 000 miles). The brake system is provided with twin brake fluid containers, one for each system. Both containers have a common filler cap. The level of the brake fluid should be between the "Max" and "Min" marks.

Only brake fluids which meet the requirements according to the specifications under .SAE 70 R 3 may be used for the hydraulic brake system.

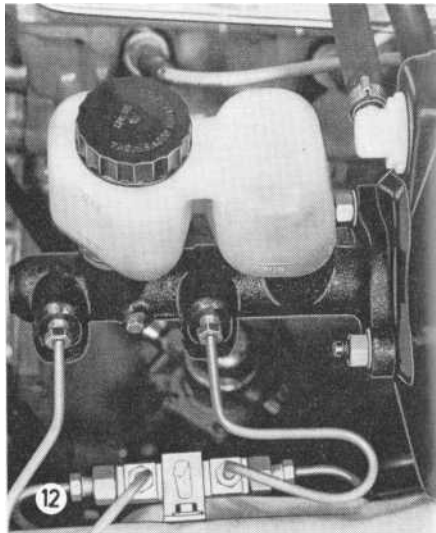

Engine

13 Crankcase ventilation

The engine is provided with positive crankcase ventilation which prevents the gases in the crankcase from being released into the atmosphere. Instead, they are sucked into the intake manifold and take part in the combustion process whereupon they are blown out through the exhaust pipe together with the other combustion gases. Every 40 000 km (25 000 miles) remove and clean the nozzle (1), the hoses (2 and 4) and the flame protector (3). Rubber hoses should also be replaced if they are in a poor condition.

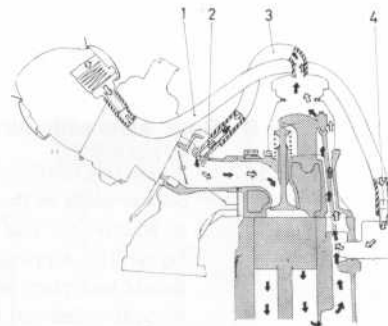

14 Oil filter

The oil filter traps any impurities in the oil so that it becomes blocked after a time. For this reason, it must be replaced for example after every 10 000 km (6 000 miles) and preferably by a Volvo workshop. If the filter is replaced without the oil being changed, 0.5 litre (approx. 1 pint) of oil should be added.

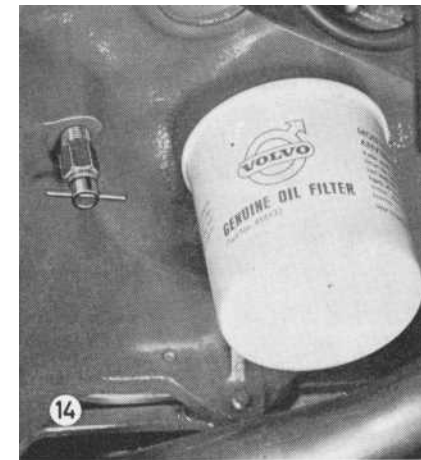

15 Fuel filter

The fuel filter should be cleaned after every 10 000 km (6 000 miles). Loosen the screw and remove the cover and strainer and clean these. When refitting the cover make sure that the gasket seals properly.

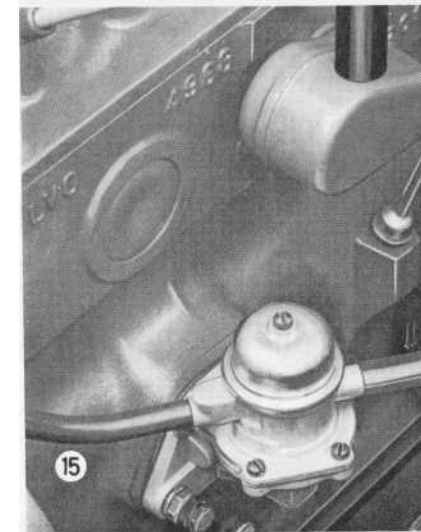

16 Air cleaner (B 20 A)

The air cleaner should be replaced with a new one after 40 000 km (25000 miles). Replacement should be more frequent if the driving conditions are dusty. **NOTE.** On no account must the element be moistened or oiled.

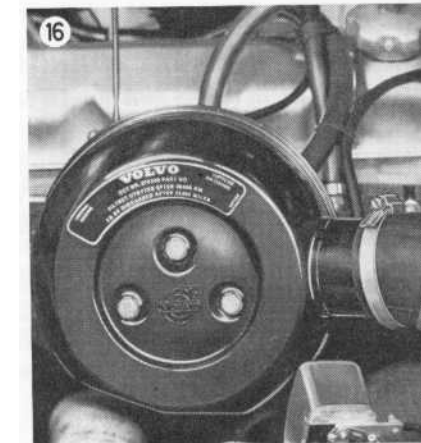

17 Air cleaner (B 20 B)

The air cleaner consists of a plastic cover with a replaceable paper insert. The insert should be replaced every 40 000 km (25 000 miles). Where driving conditions are particularly dusty, it should be changed more often. Between the interval just mentioned the insert must not be cleaned.

To replace the insert, undo the hose clamp for the preheating hose as well the clamps securing the top of the cleaner. Then remove the top so that the insert is accessible for removal.



18 Cleaning the air cleaner with foam plastic sleeve

Cars intended for markets where dusty conditions are prevalent are fitted with air cleaners provided with a foam plastic sleeve. This sleeve is normally washed or changed after every 20 000 km (12 500 miles). After every 80 000 km (50 000 miles) the paper filter must also be replaced.

The foam plastic sleeve is removed from the air cleaner and washed in paraffin (kerosene), fuel oil or warm water mixed with a washing agent. Squeeze the sleeve until it is clean and then rinse it in clean water. When the sleeve is dry, dip it in engine oil SAE 30. Squeeze the sleeve in the oil and remove surplus oil by rolling the sleeve in a clean cloth. Fit the sleeve on the paper filter.

19 Valves

Let your Volvo workshop check the engine valve clearances after every 10 000 km (6 000 miles). Too narrow clearances can cause burnt valves.

20 Compression test

Every 10 000 km (6 000 miles) a compression test should be carried out to get some idea of the condition of the engine. The test should be carried out at a Volvo workshop.

21 Fan belt

The fan belt tension should be checked every 10 000 km (6 000 miles). Due to wear or dirt, this belt can start slipping with poor cooling and poor alternator output as the result.

A way to test the tension is to press in the fan belt at a point midway between the alternator and the fan. It should be possible to press down the belt about 10 mm (3/8") with normal pressure.

The check can be suitably carried out by a Volvo workshop.

22 Check the coolant level

The cooling system must be well filled with coolant and not leak if it is to operate at maximum efficiency.

Check the coolant level when filling up with fuel. The level should be between the "Max" and "Min" marks on the expansion tank.

When the engine is new or the cooling system has been emptied, this check should be carried out with particular thoroughness.

The cooling system filler caps on the radiator and expansion tank should not be removed other than for topping up with coolant. More frequent removal may impede the circulation between the expansion tank and the engine when the latter is warming up and cooling.



Topping up with coolant

Top up with coolant when the level in the expansion tank drops down to the "Min" mark. Top up to the level of the "Max" mark. Use a good quality anti-freeze.

NOTE. Do not top up with water only, particularly during the winter. Water by itself reduces both the rust-protective and anti-freeze qualities of the coolant. Topping up with water only in the winter can also damage the cooling system due to ice forming in the expansion tank.

23 Change coolant

The coolant retains its properties for approx. 2 years when it should be changed.

To drain the coolant, open the tap on the right-hand side of the engine. Then disconnect the hose between the lower part of the radiator and the engine. This empties the radiator.

The expansion tank is emptied by lifting it up from its brackets and holding it so high that the coolant runs down into the radiator.

Before filling with new coolant, flush the entire system with clean water. The cooling system is filled with coolant through the filler opening on top of the radiator. When this has been done, the heater control should be set to max. to ensure that the entire system will be filled. Fill the radiator to the top and refit the cap. Then fill the expansion tank to the "Max" level or somewhat above this. Refit the expansion tank cap. Run the engine warm, switch off the ignition and allow the engine to cool. Then check the radiator to make sure that it is completely filled and that the level in the expansion tank is at the "Max" mark. The capacity of the cooling system is 8.6 litres (1.9 Imp. galls. = 2.3 U.S. galls.) when the level is at the "Max" mark in the expansion tank.

24 Check, replace the sparking plugs

- 25 The sparking plugs should be removed every 10 000 km (6 000 miles) and the electrode cap checked. The gap should be 0.7-0.8 mm (0.028-0.032"). After 20 000 km (12 500 miles) the plugs should be changed. This replacement should preferably be carried out by a Volvo workshop where the plugs should be tightened with a torque wrench. When fitting new plugs, be sure to fit the right type (see page 54). Consult a Volvo workshop if you intend changing to a harder or softer type of plug. The appearance of the old sparking plugs will easily tell whether or not they were the right type for your driving.

26 Ignition system

- 27 The distributor contact breaker gap should be checked at a Volvo workshop after every 10 000 km (6 000 miles). All adjusting work to the engine ignition system should be done by the workshop which has the proper equipment for this purpose. The distributor is one of the most sensitive units in the engine and careless handling can lead to decreased engine output and high fuel consumption or even serious damage to the engine.

Fuel

The petrol used for fuel should be at least 97 (ROT)* octane for the B 20 A engine. For the B 20 B type engine an octane rating of 100 (ROT)* is recommended. If petrol with too low an octane rating is used, knocking or pre-ignition can occur.

However, if highway motoring is often involved, the octane rating should be at least 97 (ROT)* even for the B 20 B engine.

* Research Method

Electrical System

The electrical system in the car is equipped with an alternator. When changing the battery or carrying out any other work with the electrical system, the following should be observed:

When changing the battery or when carrying out work involving the electrical system, the following should be observed:

1. A battery connection to the wrong terminal will damage the rectifiers. Before the connections are made, check the polarity of the battery with a voltmeter.
2. If extra batteries are used for starting, they must be properly connected to prevent the rectifiers from being damaged. The negative lead from the auxiliary battery for starting must be connected to the negative terminal stud of the car battery and the positive lead from the auxiliary battery for starting to the positive terminal stud.
3. If a rapid charger is used for charging the battery, the car battery leads should be disconnected. The rapid charger must never be used as an auxiliary unit for starting.
4. Never disconnect the battery circuit (for example, to change the battery) while the engine is running, as this will ruin the alternator immediately. Always make sure that all the battery connections are properly tightened.
5. If any electrical welding work is to be carried out on the vehicle, the earth lead and all the connecting cables of the alternator must be removed. The welding unit should be placed as near the welding point as possible.

28 Check the battery electrolyte level

To ensure that the battery functions properly, the electrolyte level should be checked regularly. A suitable time to do this is when the fuel tank is being filled. The electrolyte level should be 5-10 mm ($\frac{3}{16}$ - $\frac{3}{8}$ "") over the top of the cell plates. Top up with distilled water if necessary. Never add too much distilled water since this can cause the acid to splash over and cause damage in the engine compartment. *Never check the electrolyte level by lighting a match.* The gases formed in the cells are highly explosive.

SERVICING

29 Check the state of charge of the battery

The state of charge of the battery should be checked after every 10 000 km (6 000 miles). The check is carried out with the help of a hydrometer, this showing the specific gravity of the electrolyte which varies with the state of charge. See page 55. When checking the battery, check also the terminals and terminal bolts to make sure they are well tightened and smeared with grease or vaseline. If necessary, wipe off the terminals and terminal bolts with a rag or brush them with a wire brush before greasing them.

30 Check headlight alignment

The alignment of the headlights should be checked in a Volvo workshop after every 10 000 km (6 000 miles). Remember that the section of the road lit up by the headlights can vary depending on the load in the vehicle.

Replacement of bulbs

To obtain maximum lighting effect and to forestall the chances of lights going out, the headlights bulbs should be changed every year, suitably during the autumn. Some of the bulbs have two functions, for example, the headlight bulbs which have filaments for both mainbeam and dipped lights. The guide pins on the sockets of these bulbs are either of different thickness or they are staggered so that the bulbs can only be fitted in one definite position. Certain makes of bulbs have a "Top" mark on the socket and this should face upwards.

Replacing the roof light bulb

When replacing the roof light bulb, the lamp shade is pulled straight out.

[[When fitting headlight bulbs do not touch the glass with your fingers. The reason for this is that grease, oil or any other impurities can be carbonized onto the bulb and this may damage the deflector.



Replacing the headlight bulbs

- Loosen the three screws retaining the rim with a screwdriver.
- Pull out the bottom part of the rim slightly and then lift upwards so that the retainer catch releases its grip. (Do not pull out the headlight rim so far forwards that the catch at the top becomes bent, otherwise water can penetrate into and damage the reflector.)
- It is not necessary to remove these screws completely. The insert can be removed by turning it in an anti-clockwise direction.
- Remove the bulb holder contact and take off the rubber sleeve. Remove the spring fixing the lamp holder in the correct position.
- The bulb and holder are changed completely as one unit. When fitting the bulb holder into the insert, make sure that the small spring retainer engages in the notch.

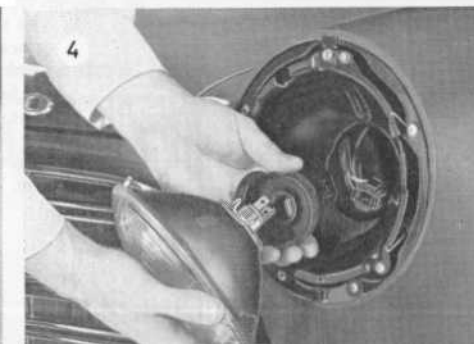

Replacing the bulbs in the front parking lights/flashers

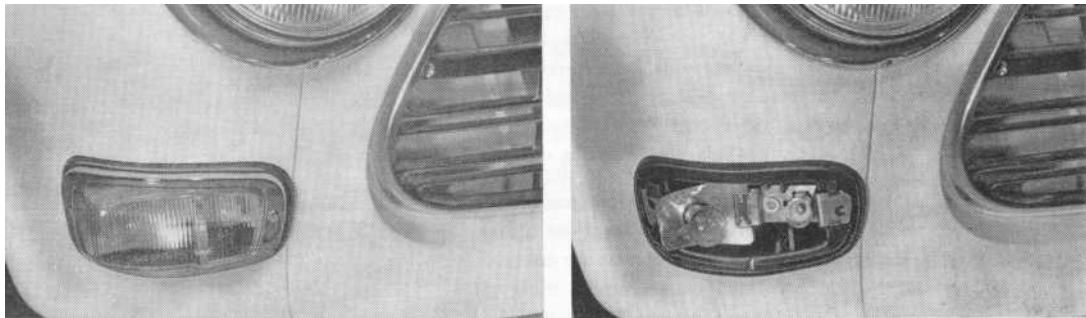

Unscrew the two screws by means of a Philips screwdriver and lift off the glass and the metal frame. The bulbs can now be removed by pushing in and twisting anti-clockwise.

The larger one is the direction indicator flasher and the smaller one the parking light. Make sure that the glass fits well against the gasket.

Replacing the bulbs in the rear flashers, stop/tail lights and reversing light

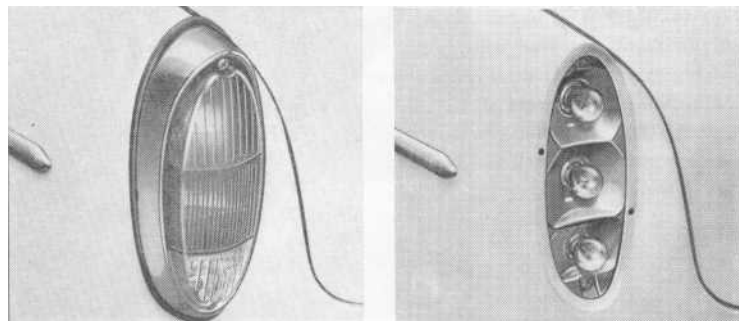

Unscrew the two screws, one at the upper and at the lower end of the lighting fixture, by means of a Philips screwdriver. Lift off the glass and the metal frame. The bulbs can now be removed by pushing in and twisting anti-clockwise.

The top bulb is the direction indicator, the middle one the combined stop/tail light, and the bottom one the reversing light. Make sure that the glass fits properly on the sealing strip when assembling the fixture. The untinted part of the

Replacing the bulbs in the number plate light

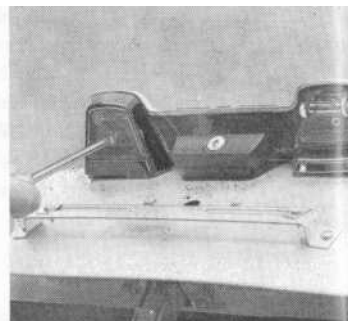

glass should be at the bottom. The number plate light is built into the handle on the luggage compartment lid with one bulb on each side of the emblem. The bulbs are accessible from the underside of the emblem.

Power transmission

31 Checking the clutch yoke free travel

To avoid risk of the clutch slipping, the clutch yoke free travel should be checked and adjusted if necessary every 10 000 km (6 000 miles). For data see page 55.

The clutch should be checked and adjusted at a Volvo workshop since these workshops have the proper equipment.

32 Check the propeller shaft

Every 10 000 km (6 000 miles) or once a year the rubber seal on the spline shaft should be checked as well as the universal joints. If the rubber seal is damaged, it should be replaced and the new seal filled with molybdenum disulphide grease.

Brakes

33 Check and overhaul the brakes

After every 10 000 km (6 000 miles) vehicles should be taken to a Volvo workshop for a check on the functioning of the brakes.

In connection with this check, the brakes should also be inspected for wear.

Every third year or 60 000 km (36 000 miles) the brakes system seals should also be replaced.

34 Replacing the booster cylinder air filter

Normally, the booster cylinder air filter should be replaced every 40 000 km (25 000 miles). Where driving conditions are mainly dusty, replace more often.

Replacement should be done by a Volvo workshop which has the proper equipment.

Front end

35 Check the front wheel alignment

Correct front wheel alignment is of vital importance for the steering of the vehicle. Faulty adjustment can mean heavy wear on the tyres. For this reason, have the front wheel alignment checked regularly at your local Volvo workshop, for example after every 10 000 km (6 000 miles). If the vehicle has met with a collision involving heavy impact and it is suspected that the front end may have been affected, take the vehicle to a Volvo workshop for a check on the front wheel alignment as soon as possible. Volvo workshops have special measuring equipment for this purpose and can therefore carry out this control very quickly. The front wheel alignment angles are shown on page 56.

36 Check the ball joints, tie-rod, etc.

After every 10 000 km (6 000 miles) the vehicle should be taken to a Volvo workshop for a check on the front end concerning excessive play in the ball joints, tie-rods etc. At this check, the ball joint seals should be inspected for damage and leakage. When new seals are fitted, they should be filled with the recommended grease.

SERVICING

Wheels and tyres

37 Check the tyre pressure

Always make a habit of checking the air pressure in the tyres regularly. The simplest way to do this is to check the pressure when filling the fuel tank. See page 56 for the correct air pressures.

Do not forget the spare wheel when checking the air pressure. Even if this wheel is not used, its air pressure can go down and you may find that the tyre is flat just when you need it. Do not let the spare wheel be unused for a considerable period, but change it regularly with one of the other wheels.

During driving, the temperature of the tyre rises and also the air pressure in relation to the speed of the vehicle and its load. Normally the air pressure should only be checked when the tyres are cold. If the tyres are warm, any alteration should be made in those cases when the tyres must be pumped with air.

Size 165 S 15 tyres are intended for speeds up to 175 km.p.h. (110 m.p.h.). For prolonged driving at speeds above 140 km.p.h. (90 m.p.h.) the air pressure in the tyres should be increased by 0.3 kg/cm² (4.5 lb./sq. in.). The pressure must not exceed 2.1 kg/cm² (30 lb./sq. in.).

For size 165 SR 15 tyres, the air pressure should be 1.8 kg/cm² (25.5 lb./sq. in.) front, and 2.2 kg/cm² (31.0 lb./sq. in.) rear, irrespective of the driving speed. If inspection of the tyres shows that there are worn spots and unusual wear on the tread, take the vehicle to a Volvo workshop for the wheels to be balanced. Check also that the tread pattern is not less than 1 mm (1/32") in depth. If it is, the tyre must be changed.



Excessively low air pressure is one of the most common reasons for tyre wear. If the pressure is too low, the tread shoulders bear the entire load and wear down very quickly. Tyres which are insufficiently inflated also result in difficult steering and high fuel consumption. Excessively high air pressure means tyre wear along the centre of the tread. It also tends to make travelling less comfortable.

Avoid damaging the tyres against pavement kerbs.

Changing a wheel

Before the car is jacked up, the handbrake should be applied and one of the gears engaged to ensure that the vehicle stands still. If possible block those wheels remaining on the ground as an extra safety precaution. Remember that the handbrake operates only on the rear wheels.

Removing

- Lever off the hub cap with the help of the spade-shaped lever.
- Loosen the wheel nuts with the help of the box spanner and tommy bar. All the wheels have nuts with right-hand threads and are loosened by turning them anti-clockwise.
- Insert the lifting arm of the jack in the appropriate jack attachment of the wheel to be changed. Jack up the side of the car far enough for the wheel to turn freely.
- Unscrew the wheel nuts completely and lift off the wheel. Be careful when lifting of the wheel that the threads of the wheel studs are not damaged.

Fitting

Fit on the new wheel and tighten the nuts until the wheel makes good contact with the hub flange. Then lower the car and tighten the nuts alternately. **Warning.** On cars fitted with a differential brake, a jacked-up rear wheel must not be turned if the other rear wheel is on the ground. Because of the differential brake, turning the jacked-up wheel will also move the other rear wheel, and this may cause the car to topple off the jack.

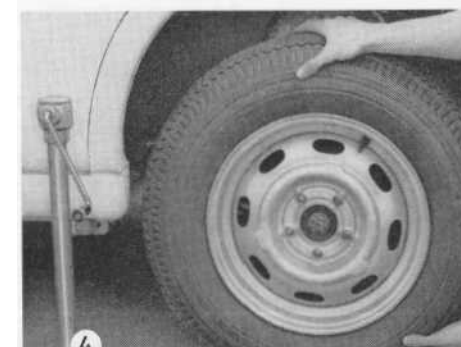
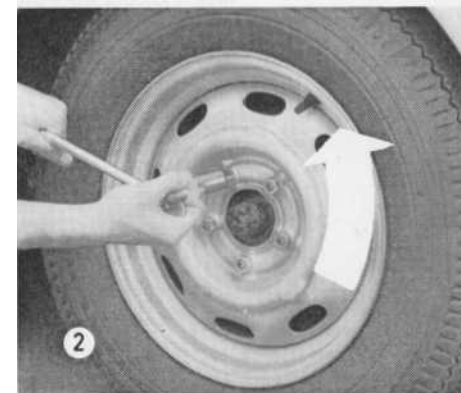

SERVICING

Body

38 Washing

The car should be washed often since such things as dirt, dust, dead insects, tar spots, etc. usually adhere firmly to the body and may damage the paintwork. Washing also helps to counteract rusting. During the winter, make sure that all road salt residue is washed off as soon as possible, otherwise corrosion can easily occur. A car, the bodywork of which has been well taken of, has of course a higher second-hand value, should the owner consider selling it.

When washing the car, make sure that it is not exposed to direct sunlight since this can cause drying patches. Begin by softening up the dirt on the underside of the body with a jet of water and use if necessary a soft brush. Then rinse down the whole body with a light jet until the dirt has loosened up. Use plenty of water. After this wash off the dirt with a sponge using plenty of water.

A washing agent can be used to facilitate washing. Special washing agents are now available on the market - even dish-washing fluids can be used.

A suitable mixture is about 5-10 cl of fluid dish washer to 10 litres (2.2 Imp. galls = 2.6 US galls) of water. Asphalt spots and tar pittings can easily be removed with white spirit or equivalent, but this should be done after the washing. Whenever a washing agent is used, the car should be well rinsed down with clean water afterwards.

After washing, dry the car with a soft, clean chamois leather. Use different leathers for the windows and the remainder of the car, otherwise using the same leather can cause greasy smears on the windows.

39 Polishing (waxing)

The car does not need polishing until the surface finish begins to lose its lustre and normal washing is no longer sufficient to make it shine again. Under normal conditions it is sufficient to polish the car a couple of times a year on condition that it is carefully looked after and thoroughly washed as soon as it has become dirty or dusty. During the winter and in coastal or industrial areas it may, however, be necessary to polish the car more often in order to avoid rusting. Before the vehicle is polished it should be carefully washed and dried so that scratches do not occur in the paintwork.

Polishing a couple of times a year is generally sufficient to give the surface finish the maintenance it needs. If you want to wax the vehicle, be very careful to ensure that the surface is absolutely clean before application. Often it is necessary to use white spirit for cleaning.

Waxing should neither be considered as a substitute for polishing nor as a necessary protection for the paintwork against unfavourable weather. For the most part waxing is not necessary until one year after delivery of the car.

Use only a good quality polish intended for a synthetic finish. Never polish or wash the vehicle in direct sunlight as this can easily result in a smeary surface.

Touching-up surface finish damage

The touching-up of any extensive damage to the synthetic finish requires the use of special equipment and skill, so that the repairing of any such damage should be entrusted to a Volvo workshop. Minor damage caused by flying stones, etc. and small scratches can, however, be attended to by you yourself.

Damage caused by flying stones requires immediate treatment. Therefore, make a habit of checking the finish and carrying out touching-up work regularly - for example when washing the car. Volvo dealers can supply you with suitable touching-up paint with brush. Always check to make sure that you get exactly the right colour.

- 1 If flying stones should penetrate the paintwork and reach the metal of the bodywork, the damaged surface is to be scraped completely clean with a penknife or similar. If, however, the paintwork is not damaged by stones, then all that is needed is light scraping to remove the dirt.
- 2 The picture shows a damaged spot scraped clean with "chamfered" edges ready for touching-up.
- 3 In the event of severe damage due to flying stones, it is necessary to treat the spot with anti-rust primer. This can be applied with a matchstick or fine brush. The primer should cover the whole of the scraped and "chamfered" surface.
- 4 When the anti-rust primer has dried, genuine Volvo paint is applied. Stir the paint well (but not with a brush). Apply several thin coats of the paint allowing it to dry thoroughly between each application.

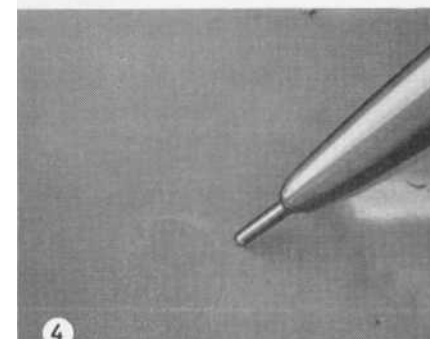
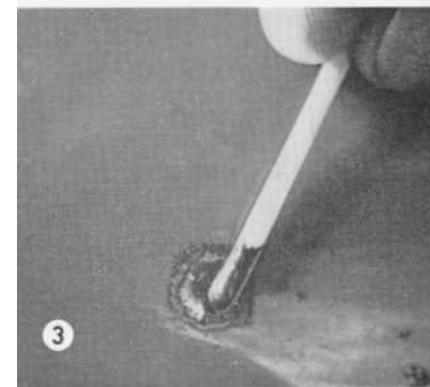
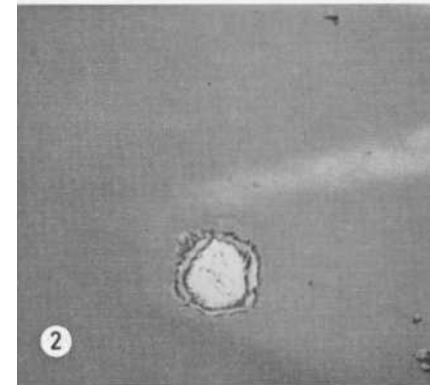
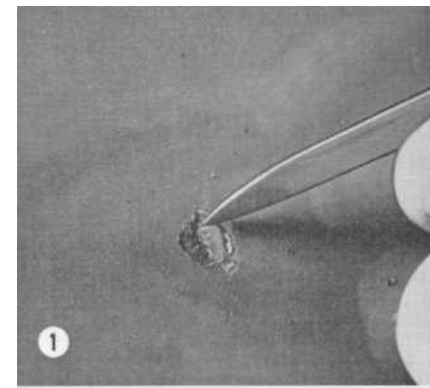

Chromed parts

The chromium-plated and anodized parts should be washed with clean water as soon as they become dirty. This is particularly important if you drive on gravel roads which are treated with chemicals to keep down the dust or in the winter when salt is used to melt down the snow or if you drive near the sea. After washing you can apply wax or anti-rust preparation.

40 Anti-rust treatment

The Volvo 120 models are anti-rust treated at the factory. The door sills are made of galvanized sheet metal and do not require any maintenance. The lower part of the body is treated with underbody sealing compound on those places subjected to flying stones from the wheels, that is, the wheel arches, the entire floor and the underside of the sills. Anti-rust fluid is sprayed on the chassis parts. Inspection and touching-up of the anti-rust protection should be done at regular intervals, and at least once a year. If any touching-up of the anti-rust protection is necessary, this should be done immediately to prevent moisture from seeping in and consequently damaging it.

41 Cleaning

Cleaning the upholstery

The upholstery consists of vinyl-coated fabric which is very resistant to dirt so that it rarely requires any maintenance. If it becomes stained, the upholstery can easily be cleaned with a synthetic washing agent and lukewarm water.

Cleaning the floor mats

The floor mats should be taken out at least twice a year and cleaned and dried, particularly during the winter. The floor under the mats can be cleaned at the same time. If the mats have become stained, they can be cleaned with methylated spirit and then rinsed off with water.

Servicing before a long-distance trip

If you are thinking of travelling abroad or taking a long trip, with your car, you should first have it completely checked at a Volvo workshop. You will enjoy your journey better if you know that your car is in perfect trim. Irritating incidents can be avoided as well as expensive time-absorbing stoppages. Even if something unforeseen should happen, your journey does not need to be spoiled. Wherever you go you know you have Volvo workshops within reach to take care of your car, if it should be necessary. Do not

forget the regular servicing during trips abroad. All Volvo workshops abroad are equipped to give your vehicle the service it requires.

If you prefer to look over your vehicle yourself, the following hints are worth noting:

1. Check the brakes, front wheel alignment and steering gear.
2. Check the engine and drive units concerning fuel oil and coolant leakage.
3. Examine the tyres carefully. Replace worn tyres.
4. Check that the engine is running perfectly and the fuel consumption is normal.
5. Examine the state of the battery and clean the terminals.
6. Look over the tool equipment and check the spare wheel.
7. Check the lighting.

Procedure in cold weather

When cold weather is on the way, it is time to think of the winter servicing of your car. The first night of frost can come as a very unpleasant surprise unless preventive precautions have been taken.

Engine cooling system

A good quality anti-freeze should be used all the year round. Thus, the cooling system should always contain water plus anti-freeze and rust inhibitor, even in the summertime.

The coolant keeps its properties for approximately 2 years when it should be changed. A suitable time for doing this is during the autumn. This would ensure against possible damage caused during the winter months. When the coolant is being changed, the cooling system should be flushed out with clean water. For further details, see page 37. If the coolant has to be topped up during the winter, use only a good quality coolant. Water alone weakens both the anti-rust properties of the coolant as well as its rust-proofing effectiveness. It is a good idea when topping up with coolant to have the concentration checked in order to be certain that there is always sufficient protection against damage by frost.

Experience has also shown that extremely weak anti-freeze solutions (10-20%) are very unfavourable from the viewpoint of rust protection. For this reason, the quantity of anti-freeze should amount to 50% of the coolant, that is, 4.3 litres (7.57 Imp. pints = 9.10 U.S. pints), which is effective below -35°C (-31°F). The maximum freezing point, -56°C (-69°F) is obtained when 5.2 litres (9.15 Imp. pints = 10.97 U.S. pints) of anti-freeze is in the cooling system.

Radiator alcohol is not recommended as an anti-freeze agent since it evaporates at normal engine temperature.

Location of drain tap for cooling system

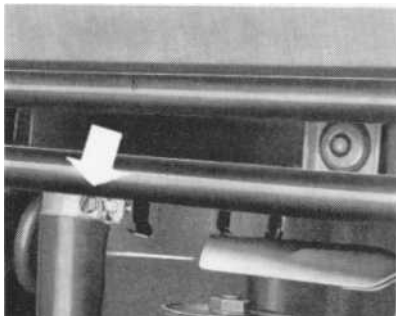

1. Right side of radiator



2. Right side of engine

Engine lubricating system

During the winter multigrade oil or engine oil with a viscosity of SAE 10 W should be used for the engine lubricating system. At continuous temperatures below -20°C (-4°F) use multigrade SAE 5 W-20. These oils reach the lubricating points mentioned more easily at low temperature and also facilitate cold starting. See page 31.

Electrical system

The electrical system in the vehicle is subjected to greater stresses during the winter than during the warm summer months. The lighting and starter motor are used more and since the capacity of the battery is also considerably lower at low air temperature, the state of charge must be checked more often and, if necessary, the battery charged. If the specific gravity of the electrolyte is excessively low, there is risk of frost damage to the battery.

Brake system

During very cold weather, the brakes are subjected to splash and condensation water which can result in the handbrake freezing up if left on. Therefore, never park the car with the handbrake applied, engage instead 1st gear or reverse and if possible place blocks behind the wheels.

Windscreen washer

In the same way as anti-freeze is added to the cooling system during the winter to prevent frost damage, anti-freeze should also be added to the water container for the windscreen washer. This is particularly important because the windscreen during the winter frequently becomes dirty and is often splashed with water which rapidly freezes and thus necessitates the frequent use of the windscreen washer and wipers. Your Volvo dealer can supply you with a suitable anti-freeze for this purpose.

Anti-freeze for door locks

A frozen door lock is one of the most irritating things that can happen to a car-owner. Many valuable minutes early in the morning can be wasted warming up keys and melting ice in locks. Remember this in *good time* and lubricate the lock with some anti-freeze preparation. These are now available in small handy tubes which can be kept in a handbag or coat pocket.

The information given below is only intended to serve as a guide in localizing and temporarily correcting minor faults. After having carried out any such measures, have them checked and adjusted by an experienced mechanic.

The engine does not start although the starter motor turns it round at normal speed

- 1 Check that there is fuel in the tank.
- 2 If the engine is warm, starting should be done with the accelerator pedal slowly depressed as far as it will go.
- 3 In wet weather the sparking plug insulators should be wiped clean and the distributor cap removed and wiped dry if flash-over is suspected.
- 4 Check that the fuel line connections on the pump and carburettor are not leaking and that fuel is supplied to the carburettor.
- 5 If the engine is turned round for a while without having started, too rich a fuel mixture can enter the cylinders resulting in the sparking plugs becoming moist. Blow the cylinders clean by screwing off the sparking plug and turning round the engine with the starter motor. *Dry* the sparking plugs before fitting them.

If the engine still does not start

- 1 Remove the ignition cable from each plug in turn. Hold the end of the cable about $\frac{1}{4}$ " from the cylinder block while turning round the engine with the ignition switched on. If there is a strong spark, the fault is probably in the sparking plugs, so these should be changed.
- 2 If only a weak spark is obtained or none at all, check to see whether the ignition cables are properly inserted in the distributor and ignition coil.
- 3 Remove the distributor cover, check and clean all contact surfaces. Check that the contact breaker points close properly when the engine is turned round. If the contact breaker arm shaft binds, oil it very sparingly.

If the engine misfires, the reason can be:

- 1 That one of the ignition cables has loosened in the distributor cover or from the sparking plug.
- 2 That one of the sparking plugs is coated with soot or oiled up, in which case the plug concerned should be cleaned or changed and the sparking plug gap adjusted.
- 3 That the distributor cover and rotor arm are cracked or damaged.
- 4 That one of the ignition cables is in poor condition.
- 5 That the contact breaker gap in the distributor is insufficient or non-existent.
- 6 That the breaker contacts are badly burned.

Measurements and weights

Length	4440 mm (175")
Width	1633 mm (64")
Height unladen (ready to drive)	1470 mm (58")
Wheelbase	2600 mm (102.4")
Ground clearance, unladen	210 mm (8.26")
Ground clearance, driver and 3 passengers	170 mm (6.69")
Track, front	1315 mm (51.77")
Track, rear	1315 mm (51.77")
Turning circle	9.5 m (31'4")
Kerb weight	1150 kg (2535 lb)

SPECIFICATIONS

Engine

Type designation	B 20 A	B 20 B
Max. output (DIN) at r.p.m.	82 h.p./4700	100 h.p./5500
Max. output (SAE) at r.p.m.	90 h.p./4800	118 h.p./5800
Max. torque (DIN) at r.p.m.	16 kgm (116 lb.ft.) 2300	15.5 kgm (112 lb.ft.) 3500
Max. torque (SAE) at r.p.m.	16.5 kgm (119 lb.ft.) 3000	17.0 kgm (123 lb.ft.) 3500
Number of cylinders	4	
Bore	88.9 mm (3.5")	
Stroke	80 mm (3.15")	
Displacement	1.99 litres	
Compression ratio	8.7:1	9.5:1
Valves	Overhead	
Valve clearance, warm and cold, inlet and exhaust40—.45 mm (.016"—.018")	.50—.55 mm (.020"—.022")
Idling speed (warm engine)	700 r.p.m.	800 r.p.m.

Fuel system

Carburettor, type	Horizontal	Horizontal
designation	Zenith- Stromberg	SU HS 6 ¹⁾
number	175 CD — 2 SE	2
Fuel, octane rating, min.	97 (ROT ²⁾)	100 (ROT ²⁾)

Cooling system

Type	Positive pressure
Thermostat, begins to open at	approx. 82°C (180°F)
fully open at	approx. 90°C (195°F)

Ignition system

Firing order	1—3—4—2	
Ignition setting, stroboscope setting with vacuum regulator disconnected .	21—23° B.T.D.C. at 1500 r.p.m.	10° B.T.D.C. at 600—800 r.p.m.
Sparking plugs, normal driving	Bosch W 175 T 35 ³⁾)	Bosch W 200 T 35 ³⁾)
hard driving	Bosch W 225 T 35 ³⁾)	
Sparking plug gap7—.8 mm (.028"—.032")	
Tightening torque	3.5—4.0 kgm (25—29 lb.ft.)	
Distributor, direction of rotation	Anti-clockwise	
Contact breaker gap4—.5 mm (.016"—.020")	

Electrical system

Voltage	12 V
Battery, type	Tudor 6 EX 4 E o.p.*)
capacity	60 Ah
electrolyte, specific gravity ..	1.28
when recharging in necessary	1.21
Alternator, max. rating	35 A
Output	450 W
Starter motor, output	1 h.p.
Fuses	8 amp—3 25 amp—1

Lamp bulbs (12 V)

	Number	Socket	Power
Headlights, asymmetrical	45/40 W	P 45 T	2
Parking lights, front	5 W	Ba 15 s	2
Flashers, front and rear	32 CP	Ba 15 s	4
Stop/parking lights, tail lights	32/4 CP	BaY 15 d	2
Reversing lights	15 W	Ba 15 s	2
Number plate light	5 W	S 8.5	2
Interior lighting	10 W	S 8.5	1
Glove compartment lighting	2 W	Ba 9 s	1
Instrument lighting	2 W	Ba 9 s	3
Warning lamps			
direction indicators	2 W	Ba 9 s	1
headlights	2 W	Ba 9 s	1
charging	2 W	Ba 9 s	1
oil pressure	2 W	Ba 9 s	1

Power transmission

Clutch

Clutch yoke free travel	3—4 mm (approx. 1/8")
-------------------------------	-----------------------

*) or corresponding

54 1) On certain markets Zenith — Stromberg 175 CD 2 SE

2) ROT = Research Method

3) Or corresponding

SPECIFICATIONS

Gearbox

Type designation	M 40
Reduction ratios: 1st speed	3.13:1
2nd speed	1.99:1
3rd speed	1.36:1
4th speed	1:1
Reverse	3.25:1

Rear axle

Type	Crown wheel and pinion (Hypoid)
Reduction ratio	4.1:1

Front wheel alignment

Alignment values apply to an unladen vehicle but include fuel, water and spare wheel.

Toe-in	0—4 mm (0 to 16")
Chamber	0 to $+1\frac{1}{2}^{\circ}$
Caster	0 to $+1^{\circ}$
King pin inclination	8°

Wheels and tyres

Tyre size	165 S 15		
Air pressure (cold tyres)			
front kg/cm ²	1—2 persons	4—5 persons	Fully loaded
lb/sq.in.	1.4	1.4	1.5
rear kg/cm ²	20	20	22
lb/sq.in.	1.6	1.8	2.0
Type size	23	26	28
Air pressure (cold tyres)	165 SR 15		
front kg/cm ²	1.8		
lb/sq.in.	26		
rear kg/cm ²	2.2		
lb/sq.in.	31		

For prolonged driving at speeds over 140 km.p.h. = 90 m.p.h. the pressure should be increased by 0.3 kg/cm² (4.5 lb/sq.in.).

The pressure must not exceed 2.1 kg/cm² (30 lb/sq.in.).

Capacities

Fuel tank	approx. 45 litres (9.9 Imp. galls. = 11.9 US galls.)
Cooling system	approx. 8.6 litres (1.9 Imp. galls = 2.3 US galls.)
Oil capacity, engine:	
when changing oil	approx. 3.25 litres (5.72 Imp. pints = 6.86 US pints)
including oil cleaner	approx. 3.75 litres (6.60 Imp. pints = 7.91 US pints)
Oil capacity, gearbox	approx. 0.75 litre (1.32 Imp. pints = 1.58 US pints)
Oil capacity, rear axle	approx. 1.3 litres (2.28 Imp. pints = 2.74 US pints)
Oil capacity, steering box	approx. 0.25 litre (.44 Imp. pint = .53 US pint)

Lubricating chart

Symbols

◆ Brake fluid
Grade SAE 70 R 3

◻ Rear axle oil
Grade: Hypoid oil
Viscosity: See pages 33 and 34

◼ Light engine oil

◻ Engine oil
Grade; For Service MS
Viscosity: Multigrade SAE 10 W-30
see page 31

**▶ Special lubricant,
see resp. notes.**

Oil capacities

Engine	3.25 litres (5.72 Imp. pints = 6.86 U.S. pints)	Rear axle	1.30 litres (2.28 Imp. pints = 2.74 U.S. pints)
Engine, incl. oil cleaner	3.75 litres (6.60 Imp. pints = 7.91 U.S. pints)	Steering box	0.25 litre (.44 Imp. pint = .53 U.S. pint)
Gearbox	0.75 litre (1.32 Imp. pints= 1.58 U.S. pints)		

Check the following when filling the tank

1. Check the engine oil level.
2. Check without removing the cap that the level in the brake fluid container is above the "Min" mark. (Right-hand steering: Check also the clutch fluid level.)
3. Check that the coolant level is between the "Max" and "Min" marks on the expansion tank.
4. Check that the fluid container for the windscreen washers is filled.

About every other week

Check the tyre pressure and the battery acid level.

Notes for lubricating chart

- Note 1** Check that the oil reaches up to the filling plug. Use all year round hypoid oil SAE 80.
- Note 2** In connection with any work in the workshop involving exposing the wheel bearings, remove the bearings, clean them and lubricate them with high-class durable grease in accordance with the instructions in the service manual. Subsequent adding or changing of this grease in addition to the above is not required.
- Note 3** Check that the fluid is between the "Min" and "Max" marks.
- Note 4** Lubricate the felt wick under the rotor and fill a few drops of light engine oil into the lubricating cup.
- Note 5** Check the oil level when filling up with petrol. Concerning changing the oil, see page 31.
- Note 6** Have the handbrake cable lubricated with graphite grease a couple of times a year.
- Note 7** Check every 10 000 km (6 000 miles) that the oil reaches up to the filler plug. Concerning oil change, see page 32.
- Note 8** At every engine oil change check that the oil level in the centre spindle of the carburettor(s) reaches up to about 6 mm ($\frac{1}{4}$) from the top of the spindle. If it does not, top up to this level. Use oil ATF type A (transmission oil).
- Note 9** The oil filter should be changed every 10 000 km (6 000 miles), see page 35.
- Note 10** Check the oil level every 10 000 km (6 000 miles). Concerning lubricant for a final drive with differential brake, see page 33.

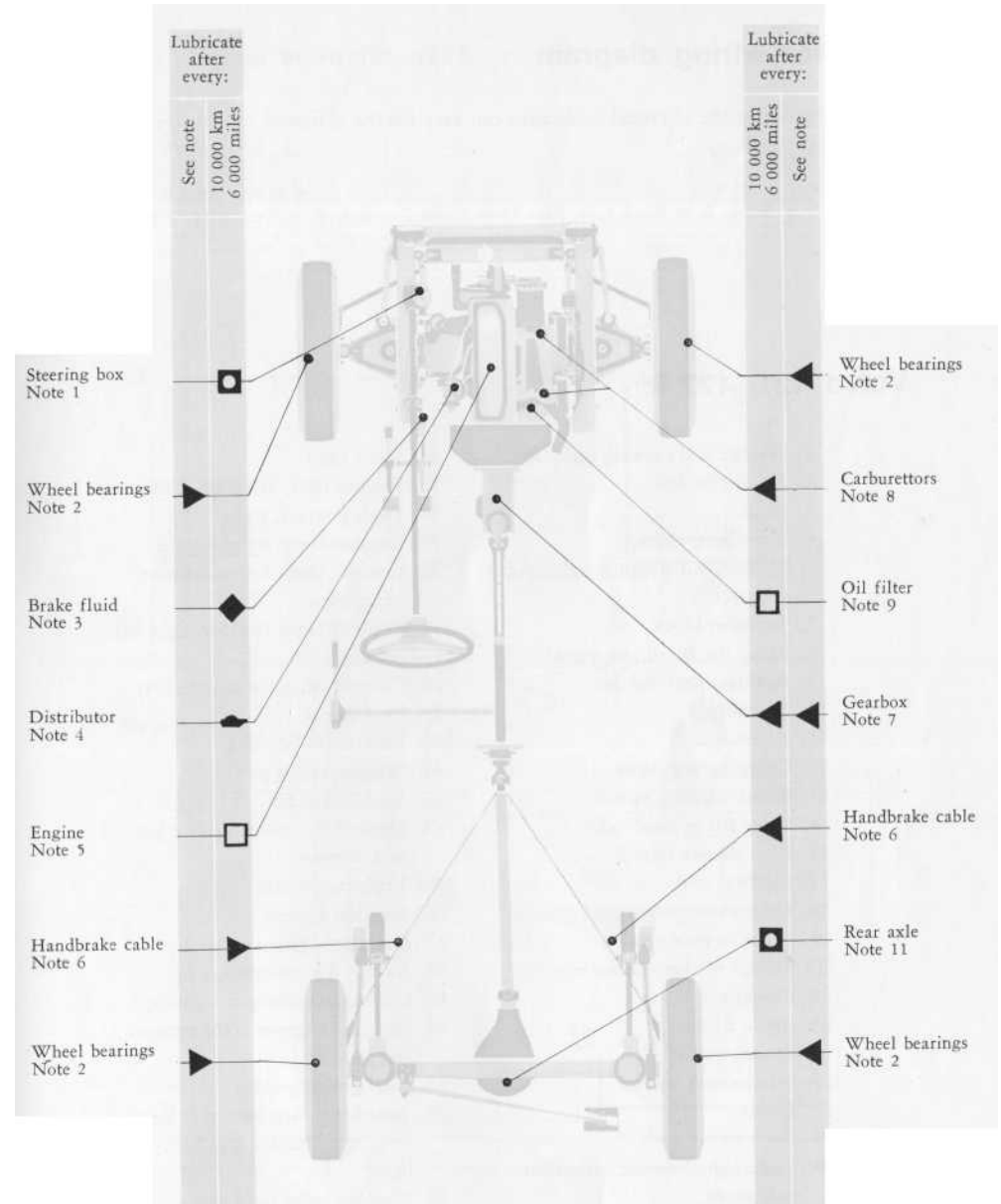

Text for wiring diagram

Note that the electrical equipment can vary for the different models on different markets.

A = White B = Black C = Blue D = Green E = Grey F = Yellow G = Brown H = Red

Wiring diagram Volvo 121, 122 S

Volvo 121, 122 S

- | | |
|-----------------------------------------------|-------------------------------------------------------------------------------|
| 1. Flasher and parking light, left | 32. Roof light |
| 2. Headlight, left | 33. Flasher unit, direction indicators |
| 3. Horn | 34. Door contact, right |
| 4. Headlight, right | 35. Control lamp for charging |
| 5. Flasher and parking light, right | 36. Control lamp for mainbeam headlights |
| 6. Connector | 37. Control lamp for direction indicators |
| 7. Junction block | 38. Control lamp for oil pressure |
| 8. Relay for headlight signal | 39. Fuel gauge |
| 9. Reverse light contact | 40. Instrument lighting |
| 10. Distributor | 41. Windscreen wiper |
| 11. Alternator | 42. Ventilation fan |
| 12. Charging regulator | 44. Control for windscreen wiper and washer |
| 13. Brake warning switch | 45. Lighting switch |
| 14. Relay for reverse light | 46. Ignition switch |
| 15. Foot dipper switch | 47. Cigarette lighter |
| 17. Ignition coil | 48. Switch for ventilation fan |
| 18. Oil pressure warning indicator | 49. Glove compartment lighting |
| 19. Brake warning lamp | 50. Switch for glove compartment lighting |
| 20. Switch for handbrake control | 51. Fuel gauge pickup |
| 21. Fusebox | 52. Rear lamp, left, with rear light, stop light, flasher and back-up light |
| 23. Brake contact | 53. Number plate light |
| 25. Starter motor | 54. Rear lamp, right, with rear light, stop light, flasher and back-up light. |
| 26. Windscreen washer | |
| 27. Battery | |
| 29. Door switch, left | |
| 30. Light signal device, direction indicators | |
| 31. Horn ring | |

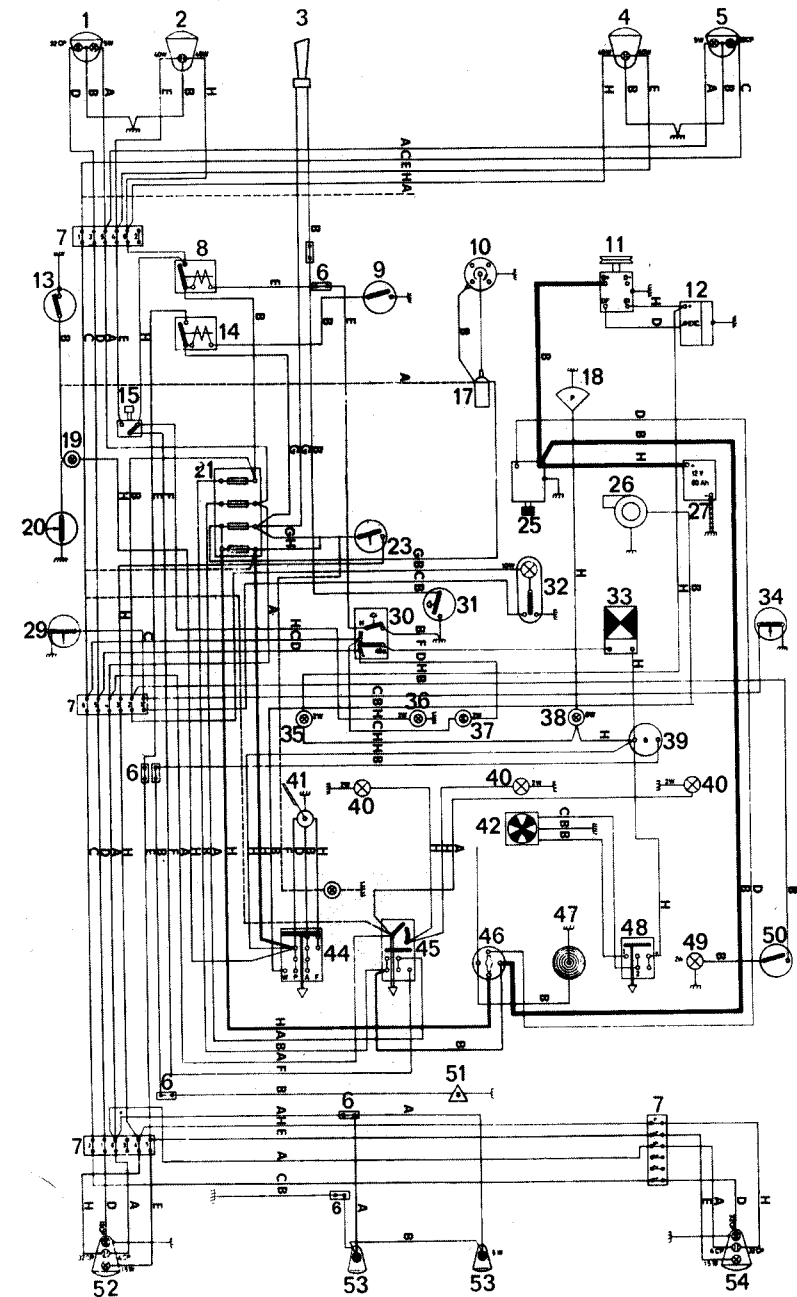

ACCESSORIES

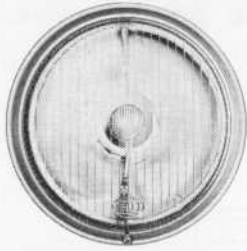

Spot light

By choosing the right accessories the motorist can often get more enjoyment from his car. When choosing accessories, you must be certain that you are receiving value for your money particularly in regard to quality, reliability and use. Genuine Volvo accessories meet all these demands, and have the same six-month factory guarantee as all other Volvo products.

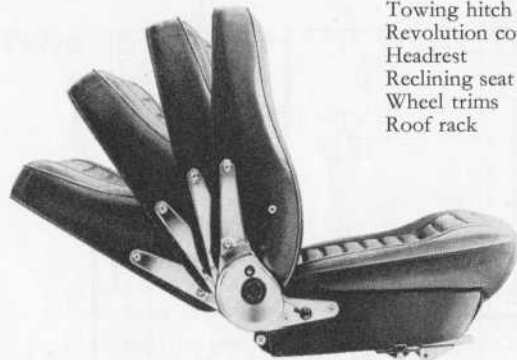

Reclining seat fittings

Towing hitch
 Revolution counter
 Headrest
 Reclining seat fittings
 Wheel trims
 Roof rack

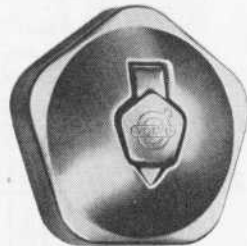

Lockable tank cap

Trunk basket
 Children's safety seat
 Safety belt for rear seat
 Fog light
 Spot light
 Lockable tank caps



Liquid wax and polish
 Car washing fluid



Revolution counter

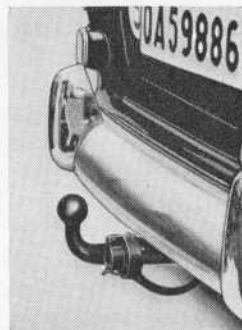

Towing hitch

Your dealer will willingly help you to find the accessories which you are looking for but which are not mentioned here. Moreover, he will be supplying you with genuine Volvo accessories with factory guarantee.

Personal information

Name _____

Address _____

Tel. No. _____

Driving Licence No. _____

Insurance Company _____

Insurance Policy No. _____

Nearest Volvo Dealer

Name _____

Address _____

Tel. No. _____

Garage Manager _____

Tel. No. _____

Car information

Type Designation _____

Chassis No. _____

Engine No. _____

Registration No. _____

Ignition Key No. _____

Door Key No. _____

Fuel Tank Lock, Key No. _____

The specifications and design details given in this book are not binding. We reserve the right to carry out modifications without previous notice.

AB VOLVO GÖTEBORG SWEDEN